

Digital Palmcorder®
Camcorder

Panasonic®

Digital Video Camcorder
Operating Instructions

Model No. **PV-DV53**

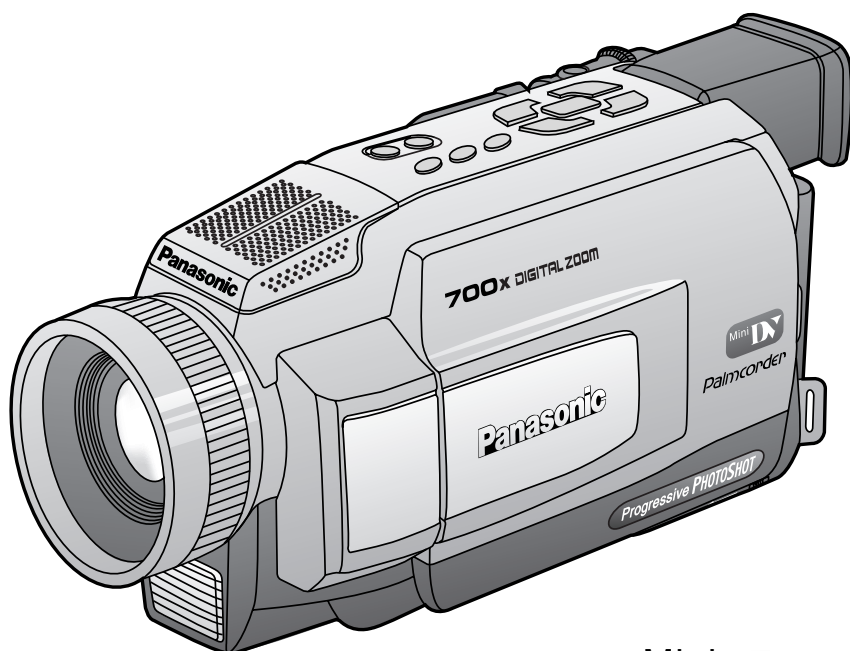

Mini **DV**

Before attempting to connect, operate or adjust this product, please read these instructions thoroughly.

Spanish Quick Use Guide is included.

Guía para rápida consulta en español está incluida.



For assistance, please call: 1-800-211-PANA(7262) or send e-mail to: consumerproducts@panasonic.com

LSQT0650B

Things You Should Know

Thank you for choosing Panasonic!

You have purchased one of the most sophisticated and reliable products on the market today. Used properly, we're sure it will bring you and your family years of enjoyment. Please take time to fill in the information below. The serial number is on the tag located on the underside of your Palmcorder. Be sure to **retain this manual** as your convenient Palmcorder information source.

Date of Purchase

Dealer Purchased From

Dealer Address

Dealer Phone No.

Model No.





Serial No.

Safety Precautions

WARNING: TO PREVENT FIRE OR SHOCK HAZARD, DO NOT EXPOSE THIS EQUIPMENT TO RAIN OR MOISTURE.

Your ^{Mini DV} Palmcorder is designed to record and play back in Standard Play (SP) mode and Long (LP) mode.

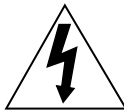
It is recommended that only cassette tapes that have been tested and inspected for use in VCR machines with the ^{Mini DV} mark be used.

	CAUTION RISK OF ELECTRIC SHOCK DO NOT OPEN	
CAUTION: TO REDUCE THE RISK OF ELECTRIC SHOCK, DO NOT REMOVE COVER (OR BACK) NO USER-SERVICEABLE PARTS INSIDE REFER SERVICING TO QUALIFIED SERVICE PERSONNEL		
		This symbol warns the user that uninsulated voltage within the unit may have sufficient magnitude to cause electric shock. Therefore, it is dangerous to make any kind of contact with any inside part of this unit.
		This symbol alerts the user that important literature concerning the operation and maintenance of this unit has been included. Therefore, it should be read carefully in order to avoid any problems.

The above markings are located on the appliance bottom cover.

Declaration of Conformity

Model Number : **PV-DV53**
Trade Name : **Panasonic**
Responsibility Party : **Matsushita Electric Corporation of America**
Address : **One Panasonic Way Secaucus New Jersey 07094**
Telephone Number : **1-800-211-PANA(7262)**

This device complies with Part 15 of the FCC Rules. Operation is subject to the following two conditions: (1) This device may not cause harmful interference, and (2) this device must accept any interference received, including interference that may cause undesired operation.

Note: This equipment has been tested and found to comply with Part 15 of the FCC Rules. These limits are designed to provide reasonable protection against harmful interference when operated in a residential environment.

If this equipment does cause interference to radio or television reception, which can be determined by turning the equipment off and on, use the equipment in another location and/or utilize an electrical outlet different from that used by the receiver.

If necessary, consult the dealer or an experienced radio/TV technician for help. You may find the booklet, 'Something About Interference' available from FCC local regional offices helpful.

FCC Warning: To assure continued FCC compliance, use only the specified shielded interface cable when connecting digital video camcorder to computer in accordance with instruction herein. Also, any unauthorized changes or modifications to this equipment would void the user's authority to operate.

Important Safeguards

1. **Read Instructions** — All the safety and operating instructions should be read before the unit is operated.
2. **Retain Instructions** — The safety and operating instructions should be retained for future reference.
3. **Heed Warnings** — All warnings on the unit and in the operating instructions should be adhered to.
4. **Follow Instructions** — All operating and maintenance instructions should be followed.
5. **Cleaning** — Unplug this video unit from the wall outlet before cleaning. Do not use liquid or aerosol cleaners. Use a dry cloth for cleaning.
6. **Attachments** — Do not use attachments not recommended by the video product manufacturer as they may be hazardous.
7. **Water and Moisture** — Do not use this video unit near water — for example near a bath tub, wash bowl, kitchen sink, or laundry tub, in a wet basement, or near a swimming pool, and the like.
8. **Accessories** — Do not place this video unit on an unstable cart, stand, tripod, bracket, or table. The video unit may fall, causing serious injury to a child or adult, and serious damage to the unit. Use only with a cart, stand, tripod, bracket, or table recommended by the manufacturer, or sold with the video unit. Any mounting of the unit should follow the manufacturer's instructions and should use a mounting accessory recommended by the manufacturer. An appliance and cart combination should be moved with care. Quick stops, excessive force, and uneven surfaces may cause the appliance and cart combination to overturn.
9. **Ventilation** — Slots and openings in the cabinet are provided for ventilation and to ensure reliable operation of the video unit and to protect it from overheating. These openings must not be blocked or covered. Never place the video unit on a bed, sofa, rug, or other similar surface, or near or over a radiator or heat register. This video unit should not be placed in a built-in installation such as a bookcase or rack unless proper ventilation is provided or the manufacturer's instructions have been adhered to.
10. **Power Sources** — This video unit should be operated only from the type of power source indicated on the marking label. If you are not sure of the type of power supply to your home, consult your appliance dealer or local power company. For video units intended to be operated from battery power, or other sources, refer to the operating instructions.



11. **Grounding or Polarization** — This video unit may be equipped with either a polarized 2-wire AC (Alternating Current) line plug (a plug having one blade wider than the other) or 3-wire grounding type plug, a plug having a third (grounding) pin. The 2-wire polarized plug will fit into the power outlet only one way. This is a safety feature. If you are unable to insert the plug fully into the outlet, try reversing the plug. If the plug still fails to fit, contact your electrician to replace your obsolete outlet. Do not defeat the safety purpose of the polarized plug. The 3-wire grounding type plug will fit into a grounding type power outlet. This is a safety feature. If you are unable to insert the plug into the outlet, contact your electrician to replace your obsolete outlet. Do not defeat the safety purpose of the grounding type plug.
12. **Power-Cord Protection** — Power-supply cords should be routed so that they are not likely to be walked on or pinched by items placed upon or against them, paying particular attention to cords of plugs, convenience receptacles, and the point where they exit from the unit.
13. **Outdoor Antenna Grounding** — If an outside antenna or cable system is connected to the video unit, be sure the antenna or cable system is grounded so as to provide some protection against voltage surges and built-up static charges. Part 1 of the Canadian Electrical Code, in USA Section B10 of the National Electrical Code, provides information with respect to proper grounding of the mast and supporting structure, grounding of the lead-in wire to an antenna discharge unit, size of grounding conductors, location of antenna discharge unit, connection to grounding electrodes, and requirements for the grounding electrode.

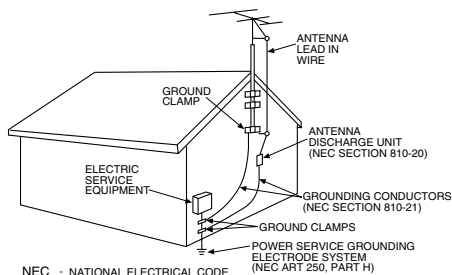

14. **Lightning** — For added protection of this video unit receiver during a lightning storm, or when it is left unattended and unused for long periods of time, unplug it from the wall outlet and disconnect the antenna or cable system. This will prevent damage to the video unit due to lightning and power-line surges.

Important Safeguards

15. Power Lines — An outside antenna system should not be located in the vicinity of overhead power lines or other electric light or power circuits, or where it can fall into such power lines or circuits. When installing an outside antenna system, extreme care should be taken to keep from touching such power lines or circuits as contact with them might be fatal.
16. Overloading — Do not overload wall outlets and extension cords as this can result in a risk of fire or electric shock.
17. Objects and Liquids — Never push objects of any kind into this video unit through openings as they may touch dangerous voltage points or short out parts that could result in a fire or electric shock. Never spill liquid of any kind onto the video unit.
18. Servicing — Do not attempt to service this video unit yourself as opening or removing covers may expose you to dangerous voltage or other hazards. Refer all servicing to qualified service personnel.
19. Damage Requiring Service — Unplug this video unit from the wall outlet and refer servicing to qualified service personnel under the following conditions:
 - a. When the power-supply cord or plug is damaged.
 - b. If any liquid has been spilled into, or objects have fallen onto, the video unit.
 - c. If the video unit has been exposed to rain or water.
 - d. If the video unit does not operate normally by following the operating instructions. Adjust only those controls that are covered by the operating instructions, as an improper adjustment of other controls may result in damage and will often require extensive work by a qualified technician to restore the video unit to its normal operation.
 - e. If the video unit has been dropped or the cabinet has been damaged.
 - f. When the video unit exhibits a distinct change in performance — this indicates a need for service.
20. Replacement Parts — When replacement parts are required, be sure the service technician has used replacement parts specified by the manufacturer or have the same characteristics as the original part. Unauthorized substitutions may result in fire, electric shock or other hazards.
21. Safety Check— Upon completion of any service or repairs to this video unit, ask the service technician to perform safety checks to determine that the video unit is in safe operating order.

Precautions

USE & LOCATION

- **TO AVOID SHOCK HAZARD ...** Your Palmcorder and power supply should not be exposed to rain or moisture. Do not connect the power supply or operate your Palmcorder if it gets wet. Your Palmcorder has been designed for outdoor use, however it is not designed to sustain direct exposure to water, rain, sleet, snow, sand, dust, or direct splashing from a pool or even a cup of coffee. This action could permanently damage the internal parts of your Palmcorder. Do not attempt to disassemble this unit. There are no user serviceable parts inside. Unplug your Palmcorder from the power supply before cleaning.
- **DO NOT AIM YOUR PALMCORDER AT THE SUN OR OTHER BRIGHT OBJECTS**
- **DO NOT LEAVE THE PALMCORDER WITH THE EVF AIMED DIRECTLY AT THE SUN AS THIS MAY CAUSE DAMAGE TO THE INTERNAL PARTS OF THE EVF**
- **DO NOT EXPOSE YOUR PALMCORDER TO EXTENDED HIGH TEMPERATURE ...** Such as, direct sunlight, inside a closed car, next to a heater, etc... This action could permanently damage the internal parts of your Palmcorder.
- **AVOID SUDDEN CHANGES IN TEMPERATURE ...** If the unit is suddenly moved from a cold place to a warm place, moisture may form on the tape and inside the unit.
- **DO NOT LEAVE YOUR PALMCORDER OR THE POWER SUPPLY TURNED ON WHEN NOT IN USE.**
- **STORAGE OF YOUR PALMCORDER ...** Store and handle your Palmcorder in a manner that will not subject it to unnecessary movement (avoid shaking and striking). Your Palmcorder contains a sensitive pick-up device which could be damaged by improper handling or storage.

CARE

- **TO CLEAN YOUR PALMCORDER ...** Do not use strong or abrasive detergents when cleaning your Palmcorder body.
- **TO PROTECT THE LENS ...** Do not touch the surface of the lens with your hand. Use a commercial Palmcorder lens solution and lens paper when cleaning the lens. Improper cleaning can scratch the lens coating.
- **TO PROTECT THE FINISH OF YOUR PALMCORDER ...** Before handling your Palmcorder, make sure your hands and face are free from any chemical products, such as suntan lotion, as it may damage the finish.

Table of Contents

Things You Should Know	2
Important Safeguards	3
Precautions	4
Before Using	6
• Easy Cassette Eject/Insertion	7
• Self Demo Mode	8
Quick Guide	9
Supplying Power	11
Setting the Clock	13
Using the Palmcorder Menu	14

Before Use

Camera Recording	15
• Simple Recording	15
• Digital PhotoShot™ Mode	17
• Zoom	18
Special Effect Features	20
Advanced Settings	23

Camera

Playback Your Recordings	27
Special Effect Features	29

VCR

Digital Features	33
Editing Features	38
PC Connection	42
PHOTOVU LINK (Optional)	44

Special Features

Palmcorder Accessory System	46
Palmcorder Accessory Order Form	47
Notes On Operations	48
Specifications	50
Before Requesting Service	51
Request for Service Notice	52
On-Screen Displays (OSD)	53
Limited Warranty	54
Customer Services Directory	55
Spanish Quick Use Guide/Guía Para Uso Rápido	56
MENU OSD	59
Electronic Viewfinder/LCD Monitor Indications	63
Index of Controls	65
Index	Back Cover

For Your Information

Before Using

Unpack your Palmcorder

1 pc. AC Adaptor (PV-DAC11) with AC Cable and DC Cable

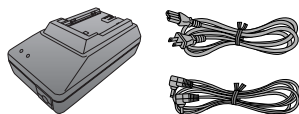

1 pc. Battery Pack (CGR-D08/CGR-D08R)

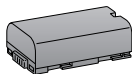

1 pc. A/V Cable (LSJA0452)

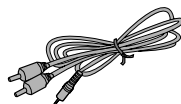

1 pc. Lens Cap (LSYF0521) with Lens Cap Strap (LSGQ0066)



1 pc. Shoulder Strap (LSFC0012)



Microsoft® and Windows® are registered trademarks of Microsoft in the United States and other countries.

Intel® Pentium® is a registered trademark.

i.LINK is a trademark.

PHOTOVU LINK is a registered trademark.

IBM is a registered trademark of IBM Company.

How to remove the Sensor tag

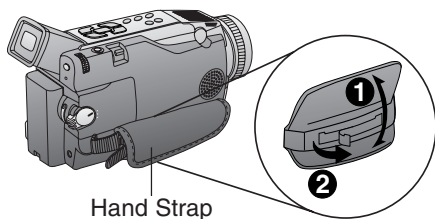

Hand Strap

- 1** Open the Hand Strap as illustrated at left.
- 2** Remove the Sensor tag. Then, replace the Hand Strap.

Erase Protection

Cassettes have a sliding record tab to ensure recordings are not accidentally erased.

- 1** To prevent accidental erasure: Slide the tab to the left (open).

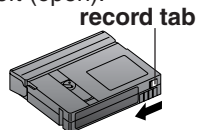

- 2** To record again: Slide the tab to the right (close).

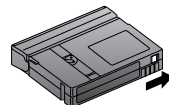

Record Speed/Playback Time

Use only those tapes having the Mini DV logo indicating the 6.35 mm digital standard.

Cassette type	Record Speed/Playback time	
	SP	LP
AY-DVM30EJ	30 minutes	45 minutes
AY-DVM60EJ	60 minutes	90 minutes
AY-DVM80EJ	80 minutes	120 minutes

Easy Cassette Eject/Insertion

- If the Palmcorder is connected to a power source, the cassette can be inserted and ejected without turning the Palmcorder on.

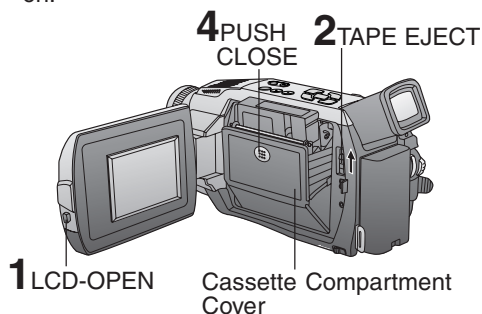

Before you begin

- Connect the Palmcorder to a power source. (pp. 11, 12)

- 1 Press **LCD-OPEN** to unlock the LCD monitor, and **swing it fully open**.
 - 2 Slide **TAPE EJECT** to open the Casette Compartment Cover.
 - 3 Insert a cassette record tab up, window side facing out.
 - 4 Press **PUSH CLOSE** to close the Casette Compartment Cover.
- **To remove the cassette...**
Slide **TAPE EJECT** to open the Casette Compartment Cover and pull the cassette tape straight out.

Note

- When inserting the cassette, make sure it is facing the right direction and then push it in completely.

Attaching the Shoulder Strap

- 1 Undo the two strap ends from their buckles.
 - 2 Thread the strap ends through the Strap Attachment Rings.
 - 3 Reinsert the strap ends through their buckles.
 - Make sure the straps are not twisted.
-
- The diagram illustrates the three steps: 1. Undoing the strap ends from buckles. 2. Threading the strap ends through the attachment rings on the camera. 3. Reinserting the strap ends through the buckles, ensuring they are not twisted.

Adjust the Length

- 1 Loosen the strap from the Buckle and create a loop.
 - 2 Pull the strap firmly through the Buckle to shorten or lengthen the strap.
-
- The diagram shows a hand pulling the strap through the buckle to adjust its length. An arrow indicates the direction of pull, and the word 'OR' is written below the strap.

Hand Strap

Adjust the length of the Hand Strap to the size of your hand as illustrated.

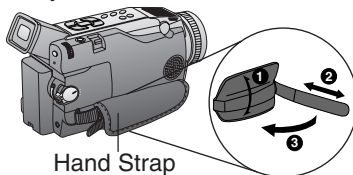

Lens Cap

Attaching the Lens Cap Strap:

Thread the Lens Cap Strap through the Strap Attachment Ring as shown.



Attaching the Lens Cap Strap to the Hand Strap:

Remove the Hand Strap from the front clasp and thread the Strap through the loop in the Lens Cap Strap. Reattach the Hand Strap.

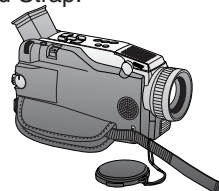

Before Using

Using the Built-in Light

To brighten the natural colors in a scene.

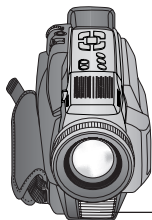

Built-in Light

Note

- Using Light reduces battery time.
- Provide adequate ventilation if using Light in a hot environment for a long time.
- Set LIGHT to OFF when not in use.
- When replacing the bulb, see page 48.

Self Demo Mode

If no operation takes place for approx. 10 minutes after the AC Adaptor was connected to the Palmcorder and the POWER Switch was turned to CAMERA without inserting a Cassette, the Palmcorder is automatically set to Self Demo mode for introducing its function. To turn it off, follow steps 1~4 below.

[EVF or LCD Monitor]

- OPTICAL 10X ZOOM
- 680K CCD
- MAGIPIX IMAGES
- VIDEO LIGHT
- DUAL IMAGE STABILIZER
- DV INTERFACE
- PROGRESSIVE PHOTO SHOT

3, 4

JOG KEY

2

MENU

1

POWER

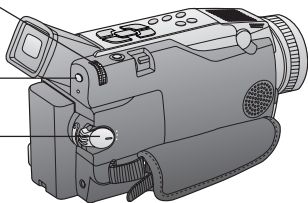

Before you begin

- Connect the Palmcorder to a power source. (pp. 11, 12)
- Set POWER to CAMERA.

1

Hold down LIGHT for more than 0.7 second to turn ON or OFF.

- "D" will appear on the screen.

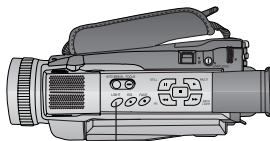

1 LIGHT

Caution

This light becomes hot during operation. Make sure nothing covers the light during operation.

Before you begin

- Connect the Palmcorder to a power source. (pp. 11, 12)

1

Set POWER to CAMERA.

2

Press MENU to display the CAMERA FUNCTIONS menu screen.

3

Rotate JOG KEY to select OTHER FUNCTIONS, and press JOG KEY to display the OTHER FUNCTIONS menu screen.

4

Rotate JOG KEY to select DEMO MODE, and press JOG KEY to select OFF.

- Press MENU to exit.

Note

- If any button is pressed or operated (except PLAY/MULTI, ZOOM and LIGHT), the Self Demo mode is canceled.
- The Self Demo mode can be started by setting DEMO MODE to ON and by exiting the menu.

To turn Self Demo back on:

- Set to DEMO MODE : ON in MENU screen.

Insert the Battery Pack

Before you begin

- Charge the Battery. (p. 11)

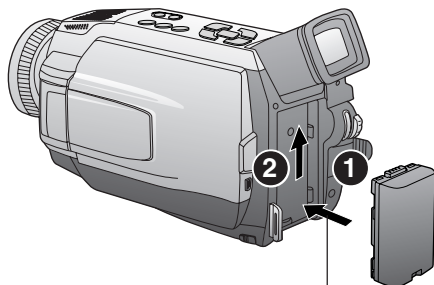

- 1** Insert the **Battery Pack** and slide it up until it locks with a click.

Insert Cassette

These Palmcorders are equipped with the Easy Cassette Eject System so it is easy to insert or remove tapes, even when on a tripod. (p. 7)

- 1** Press **LCD-OPEN** to unlock the LCD monitor, and **swing it fully open**.
- 2** Set **POWER** to **VCR** or **CAMERA**.
- 3** Slide **TAPE EJECT** to open the **Cassette Compartment Cover**.
- 4** Insert a **cassette** record tab up, window side facing out.
 - Make sure the record tab is closed. (p. 6)
- 5** Press **PUSH CLOSE** mark to close the **Cassette Compartment Cover**.

Quick Guide

Camera Recording

When the LCD monitor is fully open, the Viewfinder automatically turns OFF.

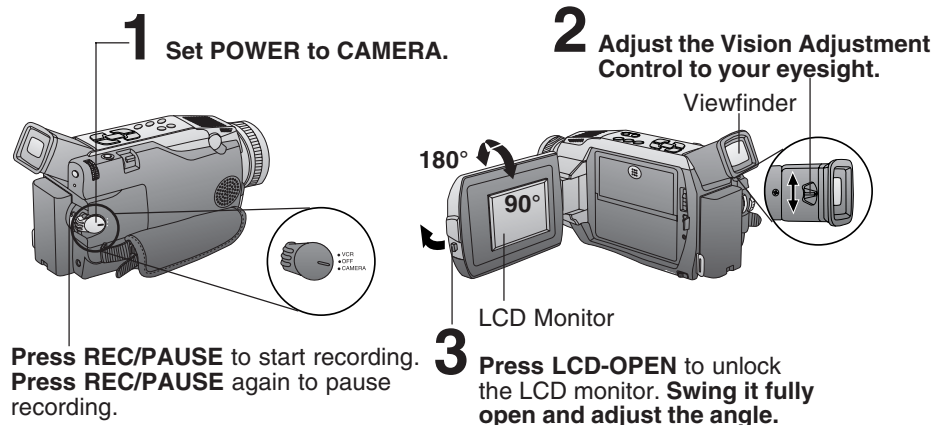
- 1** Set POWER to CAMERA.
 - 2** Adjust the Vision Adjustment Control to your eyesight.
 - 3** Press LCD-OPEN to unlock the LCD monitor. Swing it fully open and adjust the angle.
 - 4** Press REC/PAUSE to start recording. Press REC/PAUSE again to pause recording.
- 

To Watch Playback in the LCD (Liquid Crystal Display)

When the LCD monitor is fully open, the Viewfinder automatically turns OFF.

Before you begin

- Charge the Battery. (p. 11)

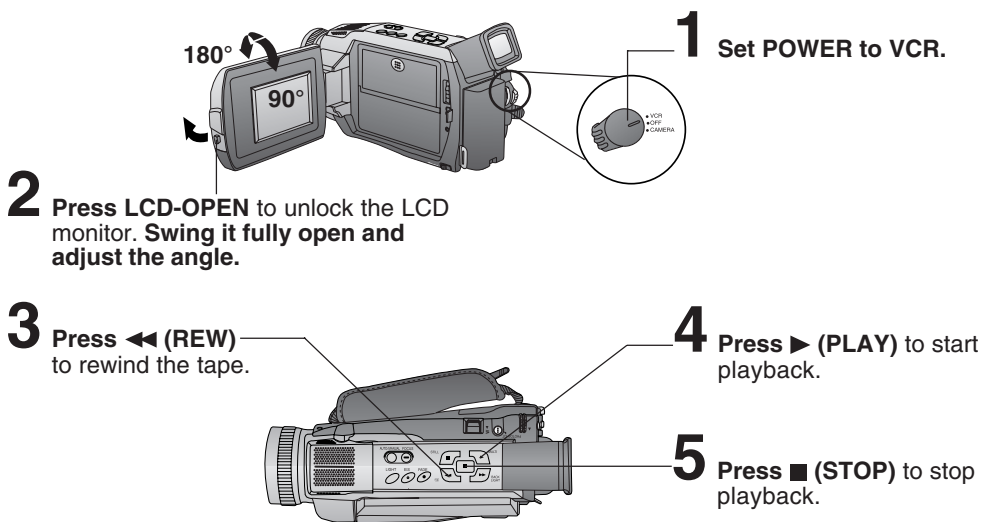
- 1** Set POWER to VCR.
 - 2** Press LCD-OPEN to unlock the LCD monitor. Swing it fully open and adjust the angle.
 - 3** Press ◀ (REW) to rewind the tape.
 - 4** Press ▶ (PLAY) to start playback.
 - 5** Press ■ (STOP) to stop playback.
- 

Charge the Battery Pack on the AC Adaptor

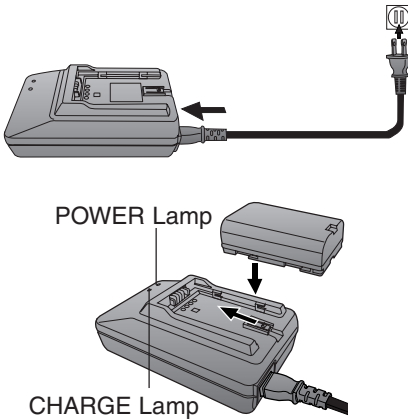

- 1 Connect and plug in the Power Cord** as shown.
 - POWER Lamp will light.
 - Remove the DC Cable, if attached, from the adaptor.
- 2 Attach the Battery as shown** to charge.
 - CHARGE Lamp lights up. It goes out when charging is complete (approx. 1 hour). Expect approx. 1 hour 50 minutes of operation (using EVF) when fully charged.
- 3 Remove the Battery.**
Slide the Battery out and then lift up.

Note

About the Flashing of the CHARGE Lamp

- Charge the Battery within an ambient temperature range of 10 °C (50 °F) and 30 °C (86 °F).
 - If charging is done in extreme low or high temperatures, Battery charge time increases.
- CHARGE Lamp flashes when...**
- The Battery is being charged, but charging is taking longer than normal.
 - Charging is not possible. Remove the Battery once, wait a short time, then re-attach it for charging.

Insert the Battery Pack

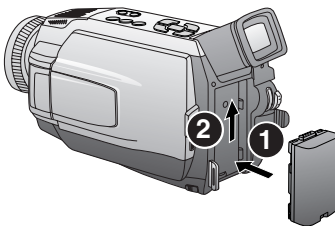

- 1 Insert the Battery Pack** and slide it up until it locks with a click.

Remove the Battery Pack

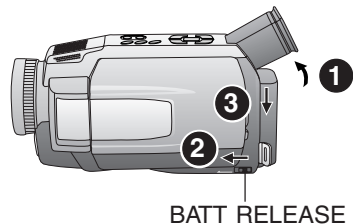

- 1 Tilt Viewfinder upward.**
- 2 Remove the Battery Pack** and slide the Battery downward while sliding the **BATT RELEASE**.

Supplying Power

Battery Care

Caution:

- Charge only with specified charger.
- Charge the Battery within an ambient temperature range of 10 °C (50 °F) and 30 °C (86 °F).
- The Battery may be warm after charging or just after use. This is normal.
- Do not use an insufficiently charged or worn out Battery.
- If charging is done in extreme low or high temperatures, Battery charge time increases.

Safety precautions:

- Do not place the Battery near, or dispose of in fire.
- Do not directly connect (short circuit) the positive (+) and negative (-) terminals.
- Never attempt to disassemble or reassemble the Battery.

To avoid damage to the Battery:

- Do not drop or jar the Battery.
- Use the Battery with specified models only.
- If the Battery is used in extremely high temperatures, a safety device will automatically prevent operation.

To insure longer battery life:

- **While not in use, remove Battery from the Palmcorder and AC Adaptor and store in a cool, dark, dry place.** If you leave the Battery in the Palmcorder or on the AC Adaptor, the Battery will no longer be rechargeable.
- Keep the Battery terminals clean.

U.S.A. CONSUMERS: ATTENTION:



A lithium ion/polymer battery that is recyclable powers the product you have purchased. Please call 1-800-8-BATTERY for information on how to recycle this battery.

Use AC Adaptor

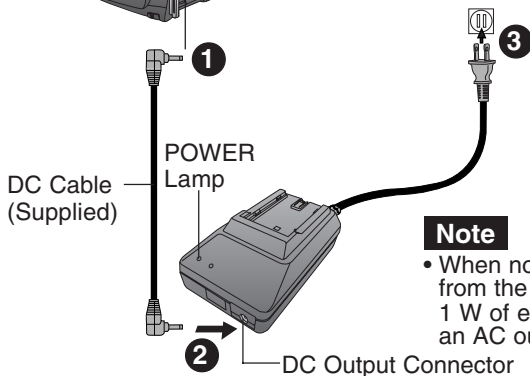
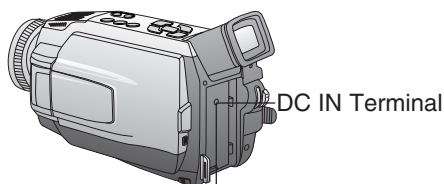
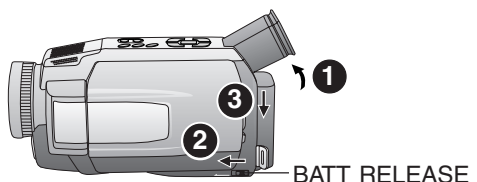

- 1 Slide the Battery downward while sliding the BATT RELEASE to **remove the Battery Pack.** (p. 11)
- 2 Insert the DC Cable into the DC IN Terminal.
- 3 Connect the other end of the DC Cable to the AC Adaptor as shown.
- 4 Plug in the AC Adaptor.
 - The POWER Lamp on the AC Adaptor lights up.

Note

- When not in use, unplug the AC Adaptor from the AC outlet. (AC Adaptor consumes 1 W of electric power when plugged into an AC outlet even when not in use.)

Setting the Clock

Set the Date and Time

The date and time is calculated, including leap year, up to DEC 31 2089.

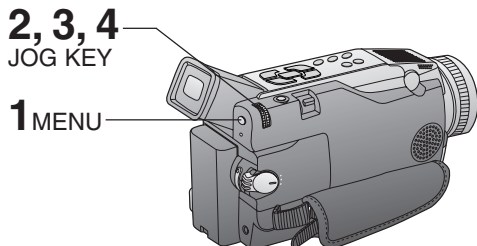

Before you begin

- Connect the Palmcorder to a power source. (pp. 11, 12)
- Set POWER to CAMERA or VCR.

- 1** Press **MENU** to display the Camera or VCR mode menu screen. (p. 14)

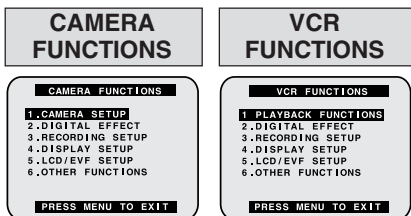

- 2** Rotate **JOG KEY** to select **OTHER FUNCTIONS**, and then press **JOG KEY** to display the OTHER FUNCTIONS menu screen.

- 3** Rotate **JOG KEY** to select **CLOCK SET**, and then press **JOG KEY** to set to ON. (Menu OSD: pp. 60, 62)
 - The CLOCK SET menu screen is displayed.

- 4** Rotate **JOG KEY** to select YEAR, then press **JOG KEY** to fix and move to the next item. Likewise, set the month, day, hour, and minute.

EXAMPLE:

YEAR : 2003

↓ Push

MONTH : JAN

↓ Rotate

MONTH : FEB

Note

- To make corrections, Press JOG KEY repeatedly to move back to an item and correct.
- A built-in Battery maintains clock operation. If the Palmcorder is not connected to a power source for a few months, the built-in battery may discharge and "CLOCK BATTERY" indication appears. (p. 53)



When CLOCK SET setting is completed, press MENU twice to start the clock and exit.

Using the Palmcorder Menu

The Palmcorder features two menu displays: one for CAMERA mode (recording) and the other for VCR mode (Playback). (pp. 59~62)

- While the Menu screen is displayed, you cannot record on or play a tape.
- While recording, the Menu screen cannot be displayed.
- During playback, the Menu screen can be displayed.

Before you begin

- Connect the Palmcorder to a power source. (pp. 11, 12)
- Set POWER to CAMERA or VCR.

2, A, B, C
JOG KEY

1, D
MENU

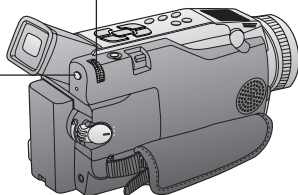

Displaying the MENU

- 1** Press **MENU** to display the CAMERA or VCR menu (according to the POWER setting).
- 2** Rotate **JOG KEY** to select a menu item.

Setting the MENU Items (EX. VCR Mode menu)

- A** Press **JOG KEY** to set your selection.
- B** Rotate **JOG KEY** to select a menu item.

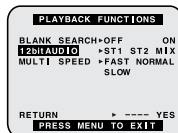
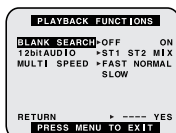

- C** Press **JOG KEY** to set your selection.
 - The "▶" mark indicates selection.
- D** Press **MENU** to exit the menu.

CAMERA Main menu

- 1: CAMERA SETUP**
To select PROG. AE, PROGRESSIVE, D. ZOOM, or CINEMA.
- 2: DIGITAL EFFECT**
To select EFFECT.
- 3: RECORDING SETUP**
To select REC SPEED, AUDIO REC, or SCENEINDEX.
- 4: DISPLAY SETUP**
To select DATE/TIME, C. DISPLAY, C. RESET, or DISPLAY.
- 5: LCD/EVF SETUP**
To select LCD BRIGHTNESS, LCD COLOR, or EVF BRIGHTNESS.
- 6: OTHER FUNCTIONS**
To select BEEP SOUND, SHTR EFFECT, CLOCK SET, SELF REC, or DEMO MODE.

VCR Main menu

- 1: PLAYBACK FUNCTIONS**
To select BLANK SEARCH, 12 bit AUDIO, or MULTI SPEED.
- 2: DIGITAL EFFECT**
To select EFFECT1, EFFECT2, or D. ZOOM.
- 3: RECORDING SETUP**
To select REC SPEED or AUDIO DUB.
- 4: DISPLAY SETUP**
To select DATE/TIME, C. DISPLAY, C. RESET, or DISPLAY.
- 5: LCD/EVF SETUP**
To select LCD BRIGHTNESS, LCD COLOR, or EVF BRIGHTNESS.
- 6: OTHER FUNCTIONS**
To select CLOCK SET.

Camera Recording

Simple Recording

Remove the lens cap and clip it to the hand strap.

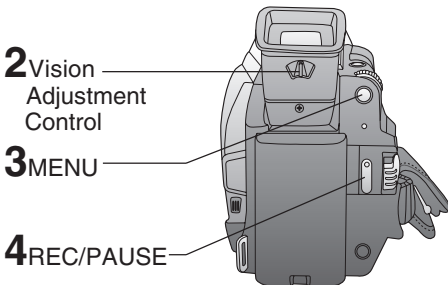
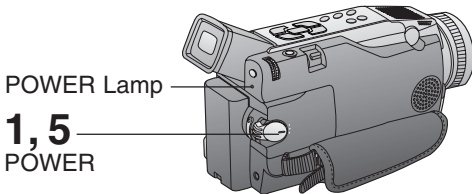
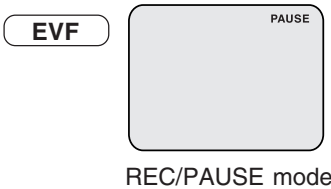
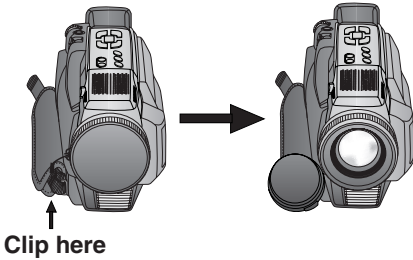

WARNING:

- Do not leave the Palmcorder with the EVF aimed directly at the sun as this may cause damage to the internal parts of the EVF.
- Do not lift, or carry, the Palmcorder by the EVF or the LCD Monitor.

Before you begin

- Connect the Palmcorder to a power source. (pp. 11, 12)
- Insert a cassette with the record tab closed. (p. 6)

- 1 Set POWER to CAMERA.**
 - The POWER Lamp lights red.
 - Be sure POWER is fully turned to the CAMERA position.
- 2 With the Viewfinder Eye Cup held up against your eye, adjust the Vision Adjustment Control to your eyesight.**
 - Adjust the EVF Brightness of the Viewfinder if necessary.
 - Please refer to "To adjust the LCD/ EVF BRIGHTNESS or COLOR" on page 16.
- 3 Set to REC SPEED "SP" or "LP" in the RECORDING SETUP menu screen.**
(Menu OSD: p. 59)
- 4 Press REC/PAUSE to start recording.**
 - "REC" is displayed on the screen.
 - Press REC/PAUSE** again to pause recording.
- 5 Set POWER to OFF** when finished.
 - To remove the cassette, slide TAPE EJECT.

- When the Palmcorder is aimed at excessively bright objects, or bright lights, a vertical bar may appear in the picture. This is a normal characteristic of the CCD pick-up device. Try to avoid this whenever possible.

To conserve power

After 5 minutes, the Record/Pause mode will automatically change to Standby mode.
To resume recording, set POWER to OFF and then ON again.

Camera Recording

Using the LCD Monitor

The LCD (Liquid Crystal Display) monitor can be used while recording.

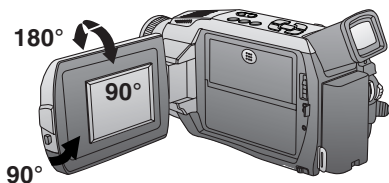
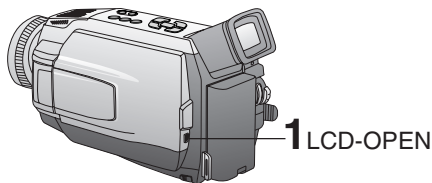

To adjust the LCD/EVF BRIGHTNESS or COLOR

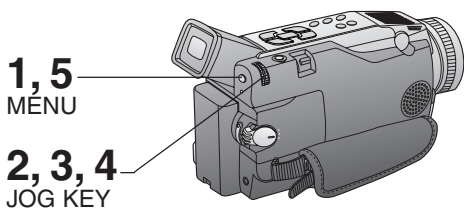

EVF/LCD



- 1 Press **LCD-OPEN** to unlock the LCD monitor.
- 2 Swing the LCD monitor fully open and adjust the viewing angle.
 - The LCD monitor will automatically turn on.
 - When the LCD monitor is completely closed, it will shut off automatically to save power.
 - Adjust the LCD Brightness and/or color of the LCD monitor if necessary. Please refer to “To adjust the LCD/ EVF BRIGHTNESS or COLOR” below.
- 3 Start recording.

Note

- Using the LCD monitor will reduce battery operating time.
- Close the LCD monitor completely when not in use.

- 1 Press **MENU** to display the main menu screen.
- 2 Rotate **JOG KEY** to select **LCD/EVF SETUP** from the main menu screen. (Menu OSD: pp. 60, 62)
- 3 Press **JOG KEY** to display the LCD/ EVF SETUP screen.
- 4 Press **JOG KEY** to select LCD BRIGHTNESS, LCD COLOR, or EVF BRIGHTNESS, then rotate **JOG KEY** to adjust.
- 5 Press **MENU** twice to exit this mode.

Camera Recording

Digital PhotoShot™ Mode

Use this feature to record a seven second (approx.) still image from the current camera picture. Audio is also recorded for on-the-spot narration. Or, you can add narration later with the Audio Dubbing feature to make an interesting slide show, etc. (p. 38)

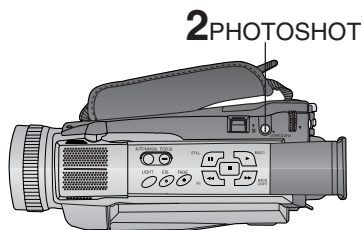
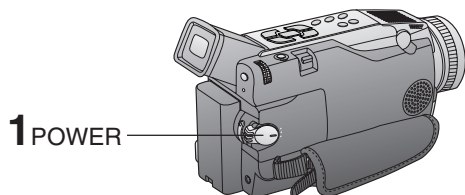

Progressive PhotoShot™ Mode

With the progressive PhotoShot Function, you can record still pictures with higher resolution than with the normal PhotoShot Function.

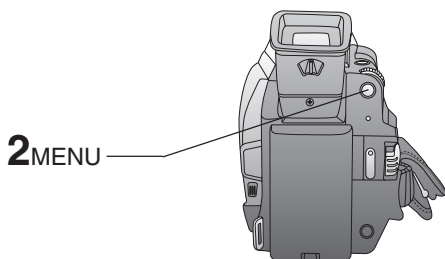
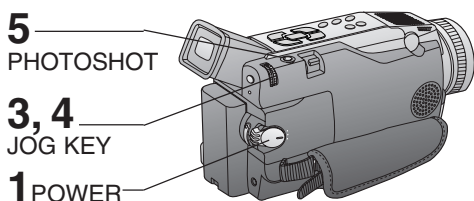

1 Set **POWER** to **CAMERA**.

2 Press **PHOTOSHOT** in Record/Pause mode. "PHOTO" will appear in the EVF or the LCD monitor.

EVF/LCD



Note

- If SHTR EFFECT on the OTHER FUNCTIONS menu screen is set to ON, a sound effect similar to the shutter of a film camera will be heard when PHOTOSHOT is pressed.
- When PHOTOSHOT is pressed, the playback image takes approx. 7 seconds to process. After that, the Camera mode screen will be displayed.

1 Set **POWER** to **CAMERA**.

2 Press **MENU** to display the **CAMERA FUNCTIONS** menu screen.

3 Rotate **JOG KEY** to select **CAMERA SETUP**, and press **JOG KEY** to display the **CAMERA SETUP** menu screen.

4 Rotate **JOG KEY** to select **PROGRESSIVE**, and press **JOG KEY** to select ON.

- Press **MENU** to exit.
- "P" will appear in the EVF or the LCD monitor.

5 Press **PHOTOSHOT** in Record/Pause mode.

EVF/LCD



Note

- This Function may not work with some function settings.

Camera Recording

Zoom

You can gradually zoom in for close ups or zoom out for wide angle shots.

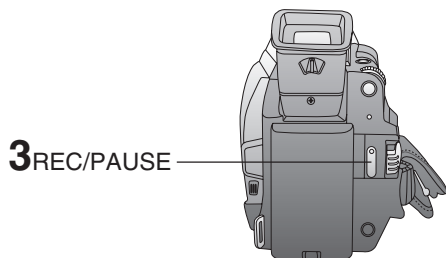
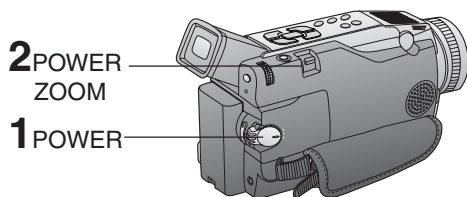

Recording Check

To playback the final few seconds of the last recorded scene in the REC/PAUSE mode.

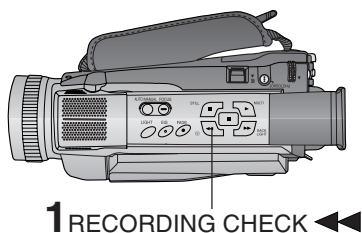

1 Set **POWER** to **CAMERA**.

2 **Zoom slowly:**
by lightly pressing the “T” (Telephoto) or the “W” (Wide Angle) side of the **POWER ZOOM**.

Zoom quickly:
by applying more pressure.

3 Start recording.

Note

- The zooming speed ranges from a slow 17 seconds to a fast 1.5 seconds according to the amount of pressure applied to the **POWER ZOOM**.

1 Press **RECORDING CHECK** ◀◀ briefly in the **REC/PAUSE** mode.

The [CHK] indication appears. After checking, the Palmcorder returns to the **REC/PAUSE** mode.

- For Recording Check, the Palmcorder must be in the same mode (SP or LP) as was used for recording, otherwise the playback picture is distorted.

Recording Still Pictures

You can record still pictures of any desired duration together with sound.

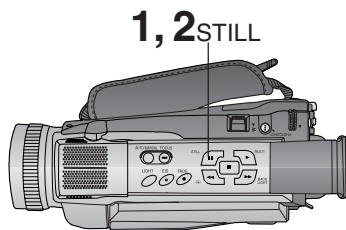

- 1** While in RECORD mode, **press STILL and hold for 2 seconds** to capture a still picture. The captured still picture will be recorded together with sound.
- 2** **Press STILL once again** to release the still picture. The camera will resume recording real-time pictures.

Self Recording

Rotate the LCD monitor 180 degrees so it faces the same direction as the lens to record yourself.

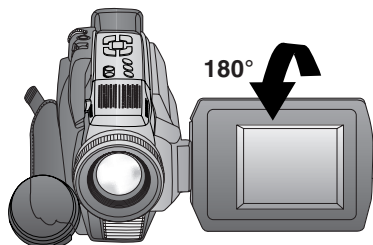
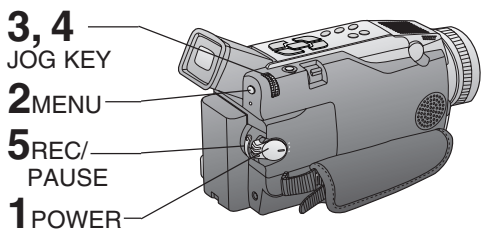

- 1** Set **POWER** to **CAMERA**.
- 2** **Press MENU** to display the **CAMERA FUNCTIONS** menu screen.
- 3** **Rotate JOG KEY** to select **OTHER FUNCTIONS**, then **press JOG KEY** to display the **OTHER FUNCTIONS** menu screen.
- 4** **Rotate JOG KEY** to select **SELF REC**, and then **press JOG KEY** to select **MIRROR**. (Menu OSD: p. 60)
 - Press **MENU** to exit.
 - The picture in the LCD monitor will appear reversed.
- 5** **Start recording.**

Special Effect Features

CINEMA Mode

You can record a picture compatible with a wide-screen TV equipped with an S-Video picture terminal and Zoom/Wide features.

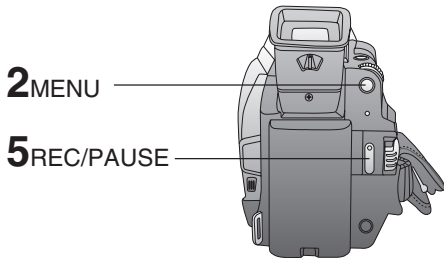
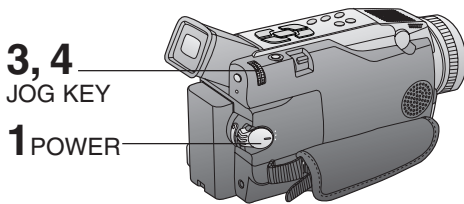

- 1 Set **POWER** to **CAMERA**.
- 2 Press **MENU** to display the **CAMERA FUNCTIONS** menu screen.
- 3 Rotate **JOG KEY** to select **CAMERA SETUP**, then press **JOG KEY** to display the **CAMERA SETUP** menu screen.
- 4 Rotate **JOG KEY** to select **CINEMA**, and then press **JOG KEY** to select **ON**.
 - A black strip will appear at the top and bottom of the picture.
 - Press **MENU** to exit.
 - "CINEMA" will appear on the screen.

- 5 Start recording.

EVF/LCD



Backlight

Use when recording a subject that is darker than the surrounding scene, is in a shadowed area, or when the light source is in back of your subject.

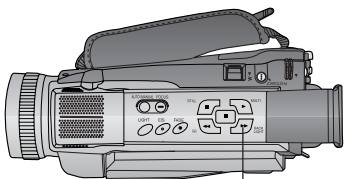
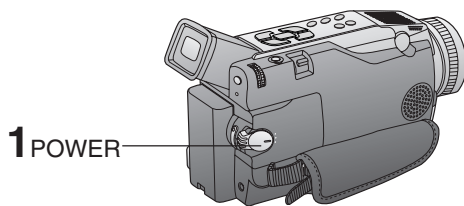

2, 3 **BACK LIGHT**

- 1 Set **POWER** to **CAMERA**.
- 2 Press **BACK LIGHT** to activate the Backlight feature.
 - The Indicator "⦿" will appear in the EVF or LCD monitor.
- 3 Press **BACK LIGHT** again to cancel the Backlight feature.

EVF/LCD

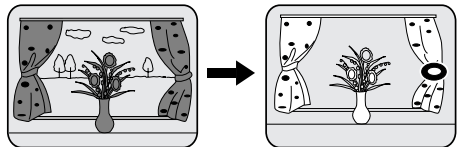

Note

- The Indicator "⦿" will not appear in the EVF or LCD monitor when **OFF** is selected in the **DISPLAY** menu.

Special Effect Features

Program AE

The Auto Exposure feature can be used to make quality recordings in a variety of scene situations.

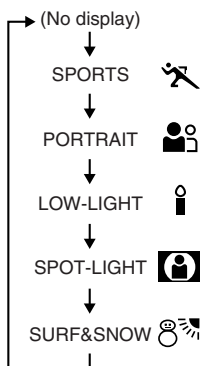
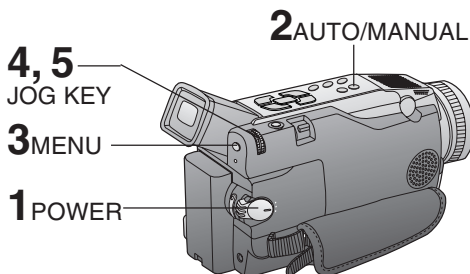





Note

SPORTS mode

- The recorded images will not be so blurred when they are viewed later using slow or still picture playback.
- When playing back a sports mode recording, the movement may appear slightly jerky.
- Do not use this mode when recording under fluorescent, mercury, or sodium lighting. These types of lights will affect the color and brightness of the images.
- A vertical band of light might appear when recording objects that are brightly illuminated or highly reflective.
- If the amount of light is insufficient, the SPORTS “” indicator will flash in the EVF or the LCD monitor.
- The image may flicker if this mode is used indoors.

- 1 Set **POWER** to **CAMERA**.
- 2 Hold down **AUTO/MANUAL** for more than **0.7 second** so that the “MNL” indication appears in the EVF or the LCD monitor.
- 3 Press **MENU** to display the **CAMERA FUNCTIONS** menu screen.
- 4 Rotate **JOG KEY** to select **CAMERA SETUP**, and then press **JOG KEY** to display the **CAMERA SETUP** menu screen.
- 5 Rotate **JOG KEY** to select **PROG. AE**, then press **JOG KEY repeatedly** to select one of the five modes shown below.
 - Press **MENU** to exit.
- 6 Repeat steps 2-5 to select **OFF** to cancel this feature.

Mode	Indication
	For recording fast action scenes.
	For recording only subjects in the foreground, while ignoring subjects in the background.
	For recording in extreme low light conditions.
	Recording in situations where subjects are under a spotlight(s).
	For recording in locations with a high degree of “Dazzle,” such as snow slopes and the seashore.

PORTRAIT mode

- The image may flicker if this mode is used indoors.

LOW-LIGHT mode

- Scenes recorded in extremely low light levels may not come out properly.

SPOT-LIGHT mode

- If the recorded subject is extremely bright, the picture may appear whitish.

SURF&SNOW mode

- If the recorded subject is extremely bright, the picture may appear whitish.
- It is not possible to select the SPORTS mode or PORTRAIT mode or Low-Light mode together with the MAGICPIX mode in the DIGITAL EFFECT camera menu.

Special Effect Features

Audio/Video Fade In/Out

You can make smoother scene transitions for a more professional look.

1, 3, **A**FADE

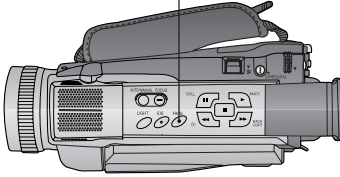

2, **B**REC/
PAUSE

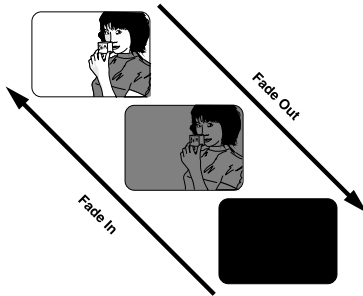
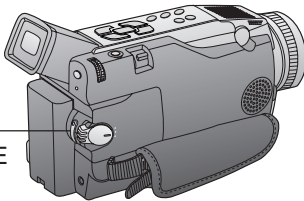

Fade In

Starting the first scene with “fade in” is very effective.

- 1** In REC/PAUSE mode, hold down **FADE** until the picture fades out.
- 2** Press **REC/PAUSE** to start recording.
- 3** Release **FADE** and the picture will gradually fade in.

Fade Out

Use to create a soft ending or (together with fade in) for a soft transition from one scene to the next.

- A** During recording, hold down **FADE** until the picture fades out.
- B** Press **REC/PAUSE** to pause the recording.

White Balance

Auto White Balance (“AWB”) automatically maintains optimum color balance in most lighting conditions. However, when using Digital Functions, etc., you may get better results by using the manual adjustment.

3, 4, A, B
JOG KEY

1 POWER

2 AUTO/MANUAL

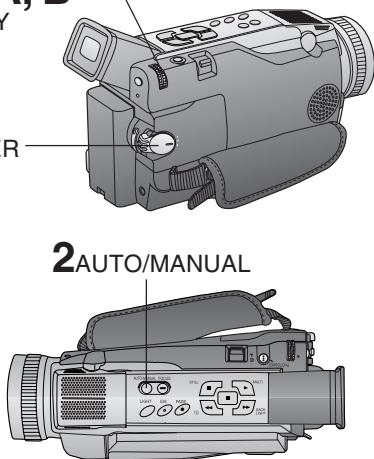

Mode	Description
AWB	Automatically maintains optimum color balance in most lighting conditions.
	When the source illumination is a halogen lamp.
	When shooting outdoors on a sunny day.
	The White Balance setting that was previously set manually. Note • When ZOOM is set to 10X or higher, White Balance cannot be adjusted.

- 1** Set POWER to CAMERA.
- 2** Hold down AUTO/MANUAL for more than 0.7 second so that the “MNL” indication appears in the EVF or the LCD monitor.
- 3** Press JOG KEY repeatedly until “AWB” appears in the EVF or LCD monitor.
- 4** Rotate JOG KEY to select other modes. (See mode chart at left.)
 - Hold down AUTO/MANUAL for more than 0.7 second to cancel the setting.

* For manual White Balance adjustment:

A. Rotate JOG KEY to select “”.

B. Point the Palmcorder at a white object (full-screen) and hold JOG KEY down until “” indication stops flashing.

- If “” indication flashes when the Palmcorder is turned on, the previous manual White Balance setting is in effect.

In the following cases, the “” indication flashes:

- The flashing indicates that the previously adjusted White Balance setting is still kept. This setting will be kept until White Balance is adjusted again.
- Correct White Balance may not be attainable manually in poor lighting.

Note

- DISPLAY must be set to ALL for MF, AE, W.BALANCE, HIGH SPEED SHUTTER, or IRIS to be displayed on the LCD or EVF.
- While “MAGICPIX” is displayed on the LCD or EVF, Manual White Balance is inoperable.

Advanced Settings

Auto Focus

The Palmcorder automatically adjusts the focus over the entire zoom range.

Manual Focus

Use Manual Focus (MF) when recording ...

- a subject through glass.
- a scene where the subject is far from the Palmcorder and there are objects in the foreground.
- a subject with distinct horizontal stripes.
- a subject not centered in the Viewfinder.
- subjects with shiny surfaces.
- an obliquely angled subject.
- a bright, flat subject such as a white wall.
- in low light situations.
- a scene with fast motions, like a golf swing.

Re-focusing may be required

- when your Palmcorder is aimed at a new scene.

4, 6 POWER ZOOM

5 M.FOCUS DIAL

1 POWER

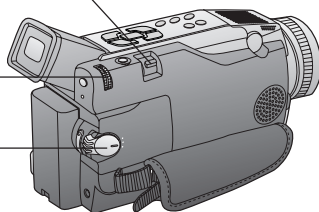

2 AUTO/MANUAL

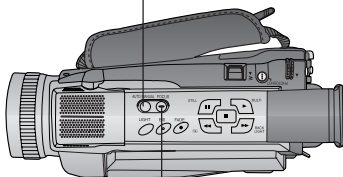

3 FOCUS

- 1 Set **POWER** to **CAMERA**.
- 2 Hold down **AUTO/MANUAL** for more than **0.7 second** so that the "MNL" indication appears in the EVF or the LCD monitor.
- 3 Press **FOCUS** so that the "MF" (Manual Focus) indication appears in the EVF or the LCD monitor.
- 4 Press and hold **POWER ZOOM**, "**T**" side (**Telephoto**), until the lens is at maximum zoom in.
- 5 Turn **M.FOCUS DIAL** until the picture is in focus.
 - It may be necessary to back away from the subject to focus the image properly.
- 6 Press **POWER ZOOM** to "**W**" or "**T**" as desired.
 - The subject will remain in focus over the entire zooming range.
 - It may be necessary to back away from the subject to focus the image properly.

Macro Focus (for close-ups)

Press the "**W**" side of **POWER ZOOM** to the maximum wide angle position.

Auto Focus will function with the subject as close as 25 mm (1 inch) in front of the lens.

Advanced Settings

High Speed Shutter

To record high speed motion (e.g. tennis stroke) with improved STILL or SLOW MOTION playback when watching the tape on this Palmcorder.

Auto Shutter

In the AUTO mode (no indication in the EVF and LCD monitor), the Palmcorder will automatically adjust the shutter speed (up to 1/350).

- AUTO mode is automatically selected whenever the POWER Switch is set to CAMERA.

Manual Selection

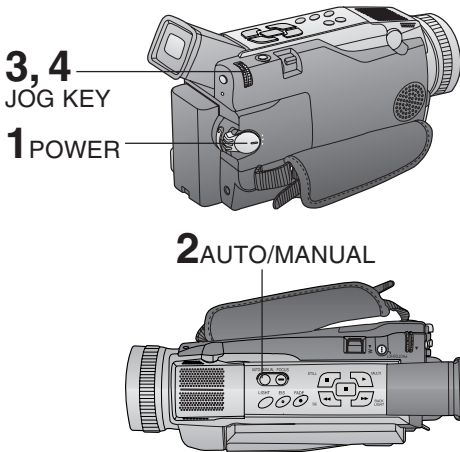

- 1 Set **POWER** to **CAMERA**.
- 2 Hold down **AUTO/MANUAL** for more than **0.7 second** so that the "MNL" indication appears in the EVF or the LCD monitor.
- 3 Press **JOG KEY** repeatedly to display the shutter speed.
- 4 Rotate **JOG KEY** to choose one of the following shutter speeds.
 - Hold down **AUTO/MANUAL** for more than 0.7 second to cancel the setting.

Note

- For proper color reproduction, it is recommended that you use this feature outdoors. For indoor High Speed Shutter recording, additional halogen or tungsten light should be provided. Fluorescent light will degrade the picture quality.
- This feature requires ample light. More light is required for the fastest shutter speeds.
- The Auto Focus system may not operate properly in insufficient light when using the High Speed Shutter.
- When PROG.AE is ON, you cannot manually select the shutter speed.
- When MagicPix is ON, H.S.S. cannot manually select the shutter speed.
- When PROGRESSIVE is set to ON, the shutter speed cannot be adjusted to 1/750 s or faster.

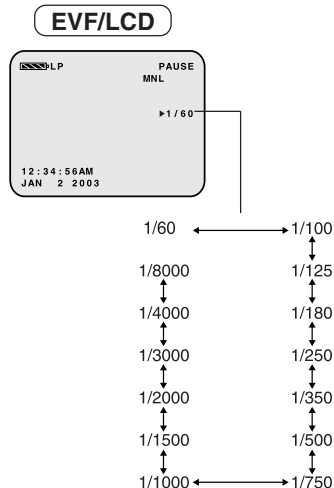

Advanced Settings

Adjusting the Iris Manually

Normally, the Palmcorder adjusts the exposure automatically. However, when the background is extremely bright, or when the subject is backlit, you can compensate by adjusting the Iris manually.

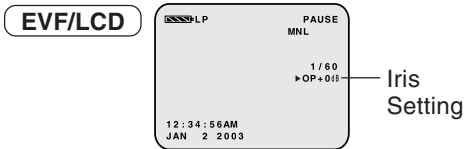
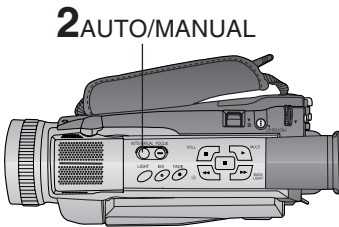
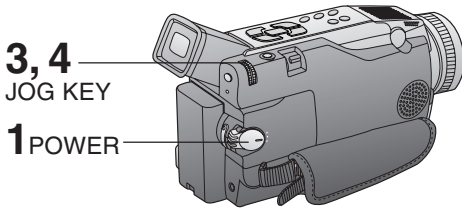

- 1 Set **POWER** to **CAMERA**.
- 2 Hold down **AUTO/MANUAL** for more than **0.7 second** so that the “MNL” indication appears in the EVF or the LCD monitor.
- 3 Press **JOG KEY** repeatedly so that Iris setting indication appears in the EVF or the LCD monitor.
- 4 Rotate **JOG KEY** to adjust the iris;
 - When a value closer to “CLOSE” is selected, the image becomes darker.
 - When a value closer to “OP+18dB” is selected, the image becomes brighter.
 - Hold down **AUTO/MANUAL** for more than 0.7 second to cancel the setting.

Note

- The value to which +dB is attached indicates a gain value. If this value is too large, the quality of the image deteriorates.
- Depending on **ZOOM** magnification, the iris value may not be displayed correctly.
- If you are using Program AE mode, you cannot adjust the iris. If the iris is adjusted manually, the above modes will be canceled.

Playback Your Recordings

Playback using the LCD Monitor

You can also use the LCD monitor to playback your recording.

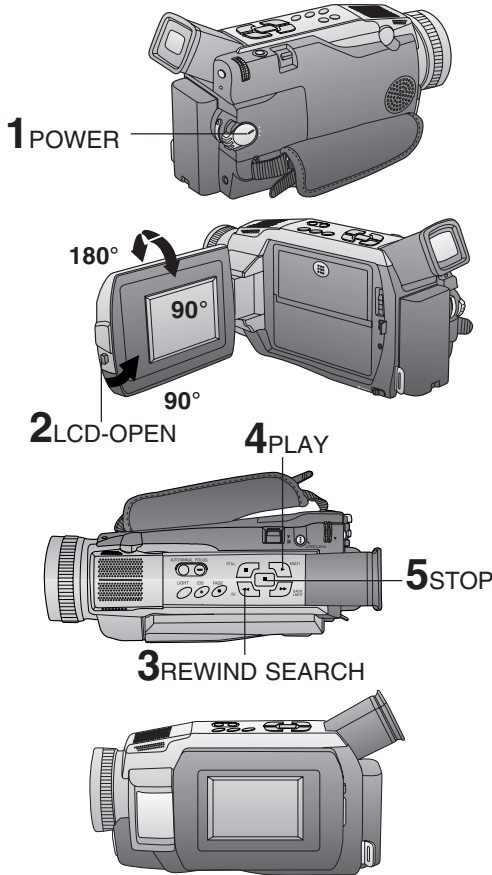

Connecting Earphone (not supplied)

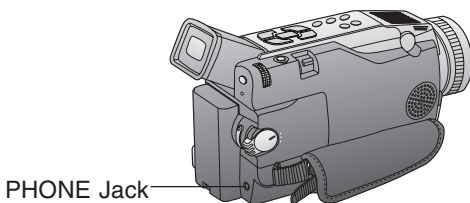

Before you begin

- Connect the Palmcorder to a power source. (pp. 11, 12)
- Insert a recorded cassette.

- 1 Set the POWER to VCR.**
 - The POWER lamp lights red.
 - Be sure POWER is fully turned to the VCR position.
- 2 Press LCD-OPEN** to unlock the LCD monitor and swing open.
- 3 Press ◀ (REWIND/SEARCH)** to rewind the tape.
- 4 Press ▶ (PLAY)** to start playback.
- 5 Press ■ (STOP)** to stop playback.
 - When the tape reaches its beginning during rewind or rewind search, it will stop automatically.

Note

- When a tape recorded in LP mode on another digital video camera is played back on this unit, the picture may appear mosaic.
- Using the LCD monitor reduces battery operating time.
- You can place the Palmcorder on a table, etc. for viewing. Rotate the LCD Monitor 180° and swing it up against the Palmcorder body as shown.

You can connect earphones (not supplied) to the PHONE Jack.

Playback Your Recordings

Repeat Playback

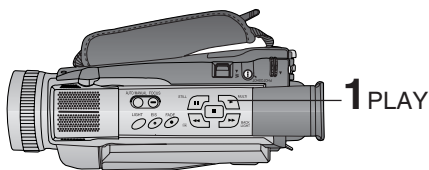

EVF/LCD



- 1 Press PLAY for more than 5 seconds** in STOP mode.
 - The Palmcorder will go into Repeat Playback mode when the tape reaches its end.
 - The letter “R ▷” will appear in the EVF and LCD monitor.
- 2 Turn the Palmcorder OFF** to exit the Repeat Playback mode.

Adjusting the Volume

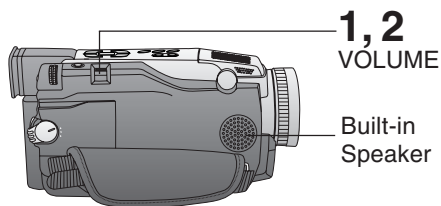

EVF/LCD

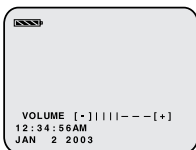

- 1 Rotate VOLUME** to adjust the volume of the built-in speaker in PLAY mode.
 - The volume setting screen appears.
- 2 Press “T”** to increase the volume. Press “W” to decrease the volume.

Blank Search

You can go directly to a blank portion of tape and start recording exactly where you left off.

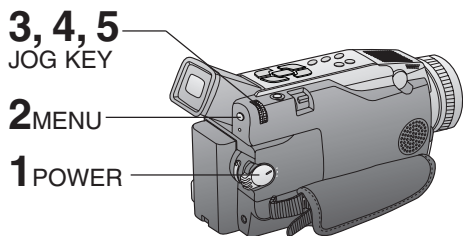

EVF/LCD

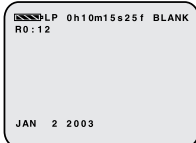

- 1 Set POWER to VCR.**
- 2 Press MENU** to display the VCR FUNCTIONS menu screen.
- 3 Rotate JOG KEY** to select **PLAYBACK FUNCTIONS**, then press **JOG KEY** to display the PLAYBACK FUNCTIONS menu screen.
- 4 Rotate JOG KEY** to select **BLANK SEARCH** in the PLAYBACK FUNCTIONS menu. (Menu OSD: p. 61)
- 5 Press JOG KEY** to select ON.
 - “BLANK” will appear on the screen.

Special Effect Features

Note

- Sound is muted during all special effects.

Rapid Visual Search

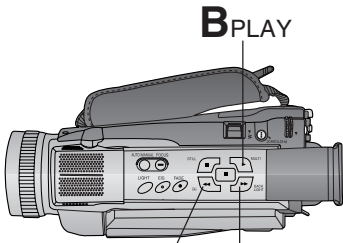

A, B REWIND/
SEARCH **A, B** FAST FORWARD/
SEARCH

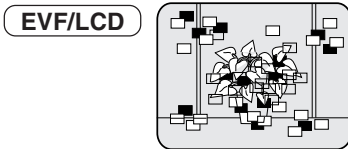

A During playback, hold down **▶▶** (FAST FORWARD/SEARCH) or **◀◀** (REWIND/SEARCH).

The search will continue for as long as the button is held down.

OR

B Press **▶▶** (FAST FORWARD/SEARCH) or **◀◀** (REWIND/SEARCH) once for a continuous rapid visual search.

Press **▶** (PLAY) to release.

Note

- When executing a rapid visual search, the picture may become bluish for an instant or mosaic. This is normal during this mode.

STILL Picture

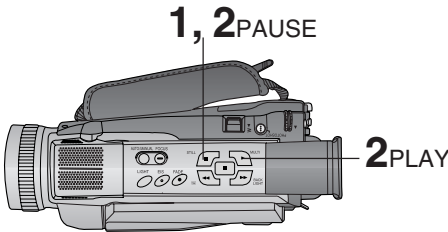

1 Press **||** (PAUSE) during playback.

2 Press **▶** (PLAY) or **||** (PAUSE) to release.

Note

- To protect the tape and video heads, your Palmcorder's operating modes will revert as follows:

STILL → STOP (after 3 minutes.)

Fast Forward/Rewind Check

Monitor normal picture playback during fast forward or rewind.

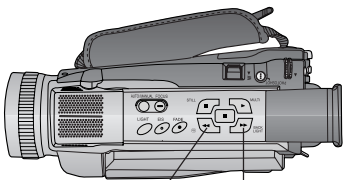

B REWIND/
SEARCH **A** FAST FORWARD/
SEARCH

A Hold down **▶▶** (FAST FORWARD/SEARCH) during fast forward.

B Hold down **◀◀** (REWIND/SEARCH) during rewind.

- The picture will appear for as long as the button is held down.

Special Effect Features

Note

- Sound is muted during all special effects.

Variable Speed Search

2, 3
JOG KEY

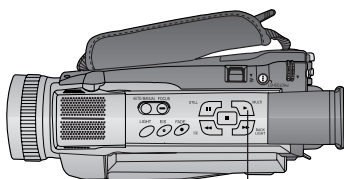
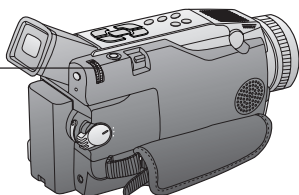

1 PLAY

- 1 Press ► (PLAY) to start playback.
- 2 Press JOG KEY for about 1 second.
- 3 Rotate JOG KEY to adjust the playback speed.
 - Rotate JOG KEY clockwise for forward playback.
 - Rotate JOG KEY counterclockwise for reverse playback.

To return to normal playback:

Press ► (PLAY). Playback will continue at normal speed.

Note

- The Variable Speed Search function offers a choice of six playback speeds (1/5X (LP mode: 1/3X), 1X, 2X, 5X, 10X, 20X) both in forward and reverse directions.
- The review playback at the 1X speed is playback in reverse direction.
- During the Variable Speed Search (except 1X speed in forward direction), mosaic-like patterns will appear in the picture.
- During the Variable Speed Search, sound is muted.
- The Variable Speed Search feature is not available when the Repeat Playback is active.

Jog Frame by Frame Search

JOG KEY

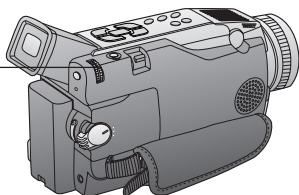

During Still mode, rotate JOG KEY to advance or reverse the picture one frame at a time.

Special Effect Features

Strobe Multi Mode

In Strobe Multi Mode, you can select the rate at which a succession of still screens are captured from the playback picture.

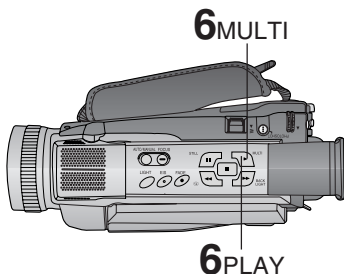
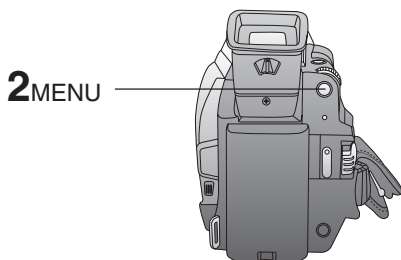
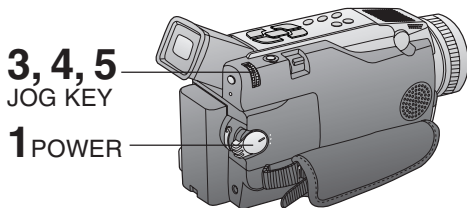

Note

- A Multi Image Playback screen cannot be output from the DV terminal or PC Connector terminal.
- A Multi screen will have slightly lower image quality.

- 1 Set **POWER** to **VCR**.
- 2 Press **MENU** to display the **VCR FUNCTIONS** menu screen.
- 3 Rotate **JOG KEY** to select **PLAYBACK FUNCTIONS**, then press **JOG KEY** to display the **PLAYBACK FUNCTIONS** menu screen.
- 4 Rotate **JOG KEY** to select **MULTI SPEED** in the **PLAYBACK FUNCTIONS** menu screen. (Menu OSD: p. 61)
- 5 Press **JOG KEY** repeatedly to set desired speed.

Strobe Speeds

Strobe Speeds	9 screen capture time
FAST	Every 0.3 seconds
NORMAL	Every 0.6 seconds
SLOW	Every 1.0 seconds

- Press **MENU** to exit.

- 6 Press **▶ (PLAY)** to start playback. Press **▶ (MULTI)** at the point you want to start capturing.
 - A succession of 9 screens will be captured, and playback will stop.

EVF/LCD

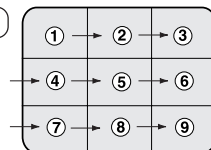

- Press **▶ (PLAY)** to start playback. Press **■ (STOP)** to stop playback.

VCR

Special Effect Features

View Recording/Playback on your TV

[TV with AUDIO/VIDEO IN Jacks]

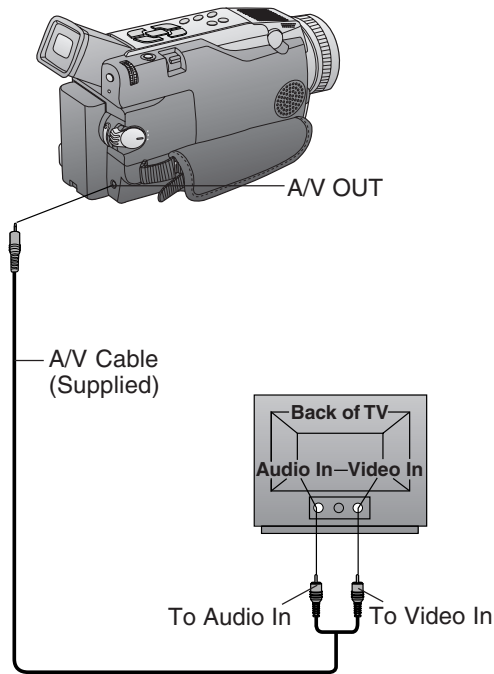

1 Set **POWER** to **CAMERA** or **VCR**.
To view what the Palmcorder is recording or to playback a tape on your TV.

2 Turn your TV **ON** and set it to **LINE INPUT**.
Check your TV operating instructions for further information.

3 Start playback or begin a recording.

- Make sure the Palmcorder and TV are turned off while connecting.
- Please connect the A/V Cable securely.

Digital Zoom

This feature is useful when you want to record close-up shots of subjects located beyond a normal zoom range of 1X to 10X magnification. With the digital zooming feature, you can select a magnification of 25X or even to 700X.

Note

- Other Digital Functions are turned off automatically when the EIS and Digital Zoom are selected.

EVF/LCD

Zoom In ("T")

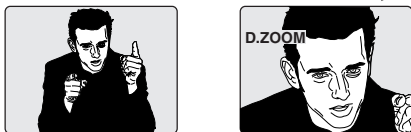

Zoom Out ("W")

5 POWER ZOOM

3, 4 JOG KEY

1 POWER

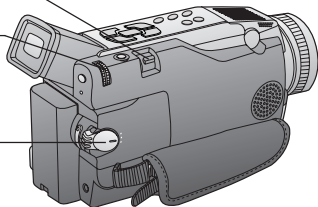

2 MENU

5 REC/PAUSE

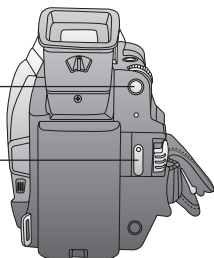

CAMERA mode

- 1 Set **POWER** to **CAMERA**.
- 2 Press **MENU** to display the **CAMERA FUNCTIONS** menu screen.
- 3 Rotate **JOG KEY** to select **CAMERA SETUP**, then press **JOG KEY** to display the **CAMERA SETUP** menu screen.
- 4 Rotate **JOG KEY** to select **D. ZOOM**, then press **JOG KEY** to select 25X or 700X.
 - 25X : from 10X to 25X
 - 700X : from 10X to 700X
 - OFF : Turn off D.ZOOM• Press **MENU** to exit.
- 5 Press **REC/PAUSE** to start recording and press **POWER ZOOM** to zoom in or zoom out.
 - The magnification level is always displayed in the EVF or the LCD monitor when **DISPLAY** is set to **ALL** or **PARTIAL**. (Menu OSD: p. 60)
- 6 Repeat steps 2-4 to select **OFF** to cancel this feature.

Note

- The normal optical zoom functions from 1X to 10X.
- As magnification increases, resolution significantly decreases.
- Because the image is enlarged digitally, the picture may become distorted when higher magnification levels are used.
- When the level falls below 10X, the normal zooming function will resume.
- Focus distance becomes 1.2 m (4 feet) if the lens is in full telephoto.

Digital Features

Digital Zoom (Continued)

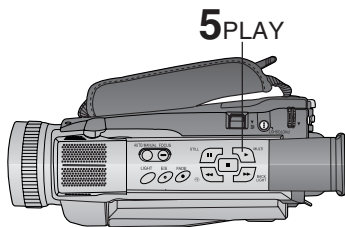
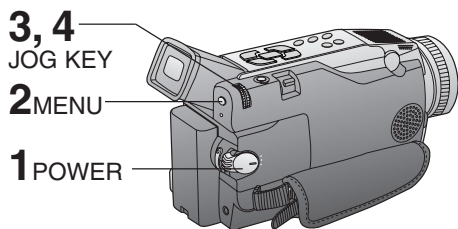

MagicPix™ Images

Color recording of video or still images onto the Mini DV tape in low lighting.
(pp. 36, 59)

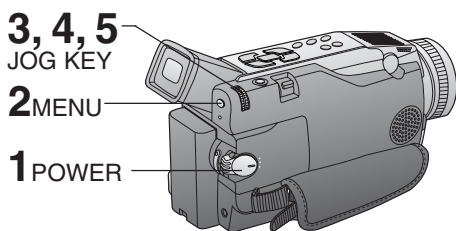

EVF/LCD



VCR mode

- 1 Set **POWER** to **VCR**.
- 2 Press **MENU** to display the **VCR FUNCTIONS** menu screen.
- 3 Rotate **JOG KEY** to select **DIGITAL EFFECT**, then press **JOG KEY** to display the **DIGITAL EFFECT** menu screen.
- 4 Rotate **JOG KEY** to select **D. ZOOM**, then press **JOG KEY** to select **ON**.
 - Press **MENU** to exit.
- 5 Press **▶ (PLAY)** to start playback.
 - The center portion of the image doubles in size.
- 6 Repeat steps 2-4 to select **OFF** to cancel this feature.

- 1 Set **POWER** to **CAMERA**.
- 2 Press **MENU** to display the **CAMERA FUNCTIONS** menu screen.
- 3 Rotate **JOG KEY** to select **DIGITAL EFFECT**, and then press **JOG KEY** to display the **DIGITAL EFFECT** menu screen.
- 4 Rotate **JOG KEY** to select **EFFECT**, and then press **JOG KEY** repeatedly to select **MAGICPIX**.
 - Press **MENU** to exit.
- 5 To cancel the Digital Function, press **JOG KEY** repeatedly to select **OFF**.

Dual Digital Electronic Image Stabilization System (D.E.I.S.)

This feature helps compensate for any unintentional hand or body movement. It can be used in both the Recording and Playback (VCR) modes.

Note

- Other Digital Functions are turned off automatically when the EIS and Digital Zoom are selected.

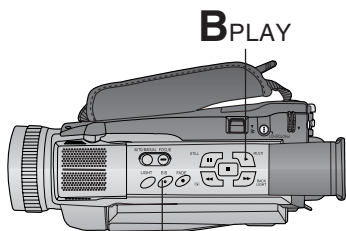
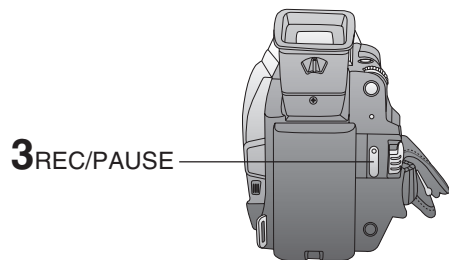
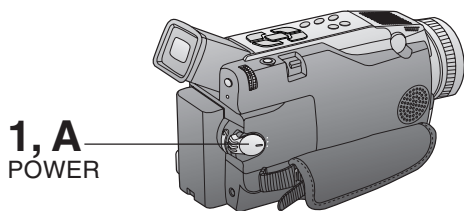
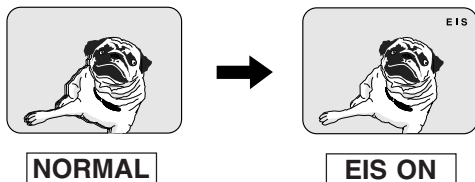

2, 4, C, D EIS

CAMERA mode

- 1 Set POWER to CAMERA.
- 2 Press EIS to stabilize the picture.
 - Picture flicker may be observed when taping under fluorescent lighting conditions.
 - The EIS indicator flashes when the light level is inadequate.
 - Turn D.E.I.S. OFF during recording when using a tripod.
- 3 Press REC/PAUSE to start recording.
- 4 Press EIS again to cancel.
 - Be sure that D.E.I.S. is turned off when not needed.

D.E.I.S. may not function when...

- Palmcorder movement is too extreme.
- Recording a subject with distinct horizontal or vertical stripes.
- Recording in low light situations.
- Recording a subject under a great amount of fluorescent light.
- Recording a scene with very fast motions.

VCR mode

- A Set POWER to VCR.
- B Press ► (PLAY) to start playback.
- C Press EIS to stabilize the picture.
- D Press EIS again to cancel.
 - Be sure that D.E.I.S. is turned off when not needed.

Note

- When using D.E.I.S. in VCR mode, the image size is slightly larger.

Digital Features

Other Digital Functions

Use the following features to add interest and professionalism to your recordings or playback. Select from twelve special effects.

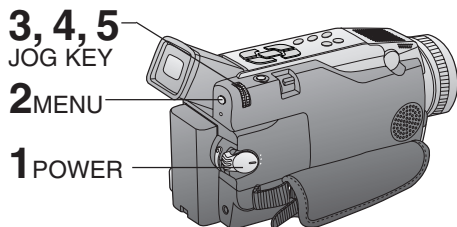

Types of Digital Functions

MIRROR

Symmetrical image from the current camera picture.

STROBE

The recording appears as a sequence of still frames.

MOSAIC

The picture appears in a mosaic pattern.

SLIM

The picture is expanded vertically.

TRAIL

The subject being recorded creates a trail when in motion.

STRETCH

The picture is expanded horizontally.

MAGICPIX (Not available during playback)
Color recording of video or still images onto the Mini DV in low lighting. (p. 34)

- Only Manual Focus is available.

WIPE (Not available during playback)

Successive scenes are separated in a way which simulates the drawing of a curtain.

MIX (Not available during playback)

The current scene is mixed in with the following scene during scene changes.

P-IN-P (Not available during playback)

PinP (Still image) is displayed on the Main Picture.

SEPIA (Only available during playback)

The picture is played back in sepia, a brownish color, giving it an antique look.

B/W (Black-and-white) (Only available during playback)

The picture is played back in black-and-white.

1 Set **POWER** to **CAMERA** or **VCR**.

2 Press **MENU** to display the menu screen.

3 Rotate **JOG KEY** to select **DIGITAL EFFECT** in the **CAMERA** or **VCR** mode menu screen, then press **JOG KEY** to display the **DIGITAL EFFECT** menu screen.

4 Rotate **JOG KEY** to select **EFFECT** in the **CAMERA** mode menu screen or **EFFECT1**/**EFFECT2** in the **VCR** mode menu screen, and then press **JOG KEY repeatedly** to select one of the Digital Functions listed on the left.

5 To cancel the Digital Function, press **JOG KEY repeatedly** to select **OFF**.

Note

- The **EIS** and **Digital Zoom** features are turned off automatically when one of the Digital Functions listed at left is selected.

To use the WIPE function

- In Camera mode, set the "EFFECT" item in the main menu screen to "WIPE". (Menu OSD: p. 59)
- Press **REC/PAUSE** to start recording.
- Press **REC/PAUSE** to pause the recording. The last scene will be memorized.
- Press **RECORD/PAUSE** to start recording again. The new scene will take the place of the memorized scene.

To use the MIX function

- In Camera mode, set the "EFFECT" item in the main menu screen to "MIX" (Menu OSD: p. 59). Then, perform steps **b-d** above.

The memorized scene and the new scene will appear mixed as the scene changes from one to the other.

Digital Features

Picture in Picture (PinP)

You can display a PinP (still image) screen on the Main Picture.

Note

- PinP position is fixed at the bottom right of the screen.

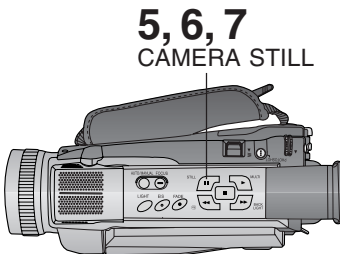
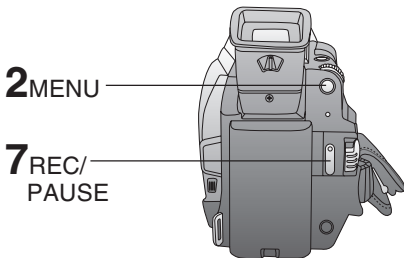
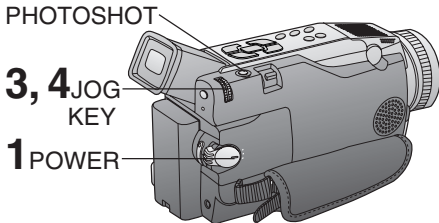
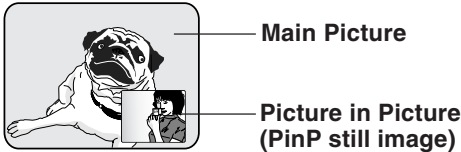

- 1 Set **POWER** to **CAMERA**.
- 2 Press **MENU** to display the **CAMERA FUNCTIONS** menu screen.
- 3 Rotate **JOG KEY** repeatedly to select **DIGITAL EFFECT**, then press **JOG KEY** to display the **DIGITAL EFFECT** menu screen.
- 4 Press **JOG KEY** to select **P-IN-P**.
 - Press **MENU** to exit this menu.
 - "P-IN-P" will appear in the EVF or the LCD monitor.

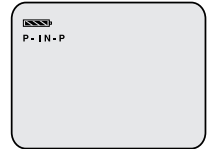

- 5 Aim at the scene you wish to place as PinP, then press **II (CAMERA STILL)** to freeze the image.
- 6 Press **II (CAMERA STILL)** again to place the frozen image as PinP.

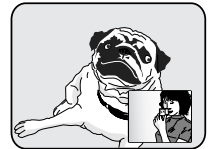

- 7 Press **REC/PAUSE** to record a scene with PinP image.
 - Press **PHOTOSHOT** to record a scene with PinP image in PhotoShot mode.
 - Press **II (CAMERA STILL)** again to remove PinP image.

Editing Features

Audio Dubbing using the Built-in Microphone

The original sound can be replaced with new sound using the built-in Palmcorder microphone.

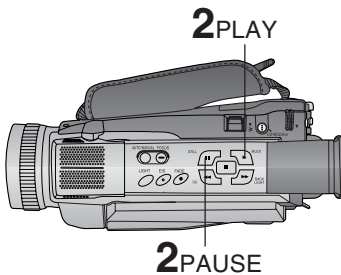
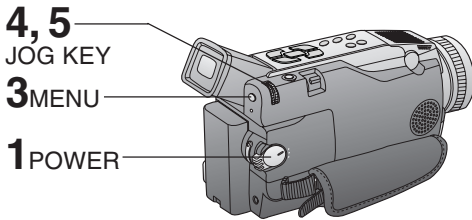
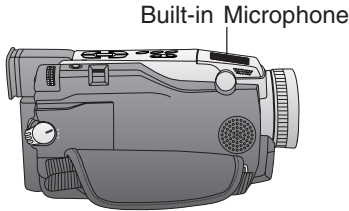

Before you begin

- Turn on the Palmcorder.
- Insert a pre-recorded tape to be dubbed.

12 bit	The original sound is recorded on ST (Stereo) 1, and the new sound will be recorded on ST (Stereo) 2.
16 bit	The original sound is replaced with the new sound.

- Select 12 bit if you do not want the original sound to be completely replaced during an audio dub.
- With tape containing both 12 bit and 16 bit audio, please note that if dubbing is started in a 16 bit portion, the 12 bit audio will also be completely replaced.

1 Set **POWER** to **VCR**.

2 Press **▶ (PLAY)**. Then press **⏸ (PAUSE)** where you want dubbing to begin.

3 Press **MENU** to display the **VCR FUNCTIONS** menu screen.

4 Rotate **JOG KEY** to select **RECORDING SETUP**, then press **JOG KEY** to display the **RECORDING SETUP** menu screen.

5 Rotate **JOG KEY** to select **AUDIO DUB**, and then press **JOG KEY** to select **ON**.

- The Palmcorder will go to Stand By mode, and "A.DUB II" indication appears in the EVF or the LCD monitor.

6, 7 PAUSE

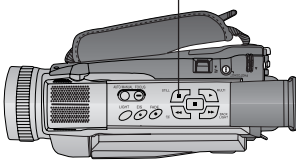

To listen to the desired audio sound, set the 12 bit AUDIO setting of the VCR mode MENU (Menu OSD: p. 61) as follows:

12 bit AUDIO:The following selections are available for 12 bit AUDIO dubbed recordings only (sound recorded in SP mode only).

ST 1	Set this position to listen to the original sound.
ST 2	Set this position to listen to the audio dubbed sound.
MIX	Set this position to listen to both the original sound and the audio dubbed sound.

Note

- When a 16 bit recording is dubbed over, the original audio of the recording will be erased.
- When a 12 bit recording is dubbed over and played back, and MIX is selected as the AUDIO, both the original audio and the dubbed audio are played back.
- If you recorded in LP mode, you cannot use the A.DUB feature.

6 Press **II (PAUSE)** to start Audio Dubbing. “A.DUB ▷” indication appears.

- Connect the Palmcorder to the TV in order to monitor the sound. (p. 32)

INCOMPATIBLE
DATA

Only NTSC (National Television Standards Committee) recorded tapes can be audio dubbed. The following screen appears if the tape was not recorded in NTSC format.

7 Press **II (PAUSE)** to stop Audio Dubbing.

- If the microphone used for dubbing gets too near the speaker of your TV, a howling noise (feedback) may occur.
- If the tape position is in or was started in a blank section, you cannot use the A.DUB feature.

Editing Features

Copying your Tapes to VHS Cassette

Source (Playing)
Palmcorder

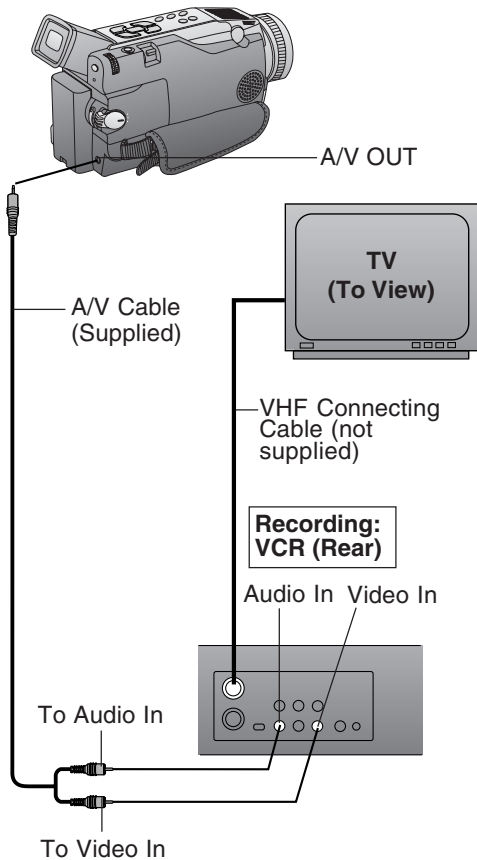

Before you begin

- Connect both Palmcorder and VCR to their power sources.
- Connect the Palmcorder to a VCR as illustrated left.
- Turn ON both units.
- **Set the recording VCR's Input Signal Selector to LINE.**
- Set the Palmcorder POWER to VCR.

- 1 Insert a pre-recorded tape** into the source (playing) Palmcorder and a blank tape, with record tab in place, into the target VCR (Recorder).
- 2 Press ► (PLAY)** on the Palmcorder. When the tape reaches the point you want to start dubbing, **press PAUSE**.
- 3 Place the VCR into REC/PAUSE mode.** (See VCR manual.)
- 4 Simultaneously, press PAUSE** on both units to begin copying.
- 5 Press STOP on both units** when copying is completed.

Note

- For technical reasons, dubbing a tape may reduce its quality.
- If the Time Code is displayed in the EVF or LCD monitor, it cannot be reset.
- Only the DATE/TIME, when displayed, will be recorded on the tape.

Monitor with your TV

- Turn the TV ON and select its VCR channel (either CH3 or CH4).
- Set the VCR/TV Selector on the recording VCR to VCR.

CAUTION:

Unauthorized exchanging and/or copying of copyrighted recordings may be copyright infringement.

Copying from Digital Equipment (dubbing)

High quality digital-to-digital copying can be accomplished if both Palmcoders incorporate the DV Input/Output (i.LINK) Connector (DV Interface cable (i.LINK) is not supplied).

Source (Playing) Palmcorder

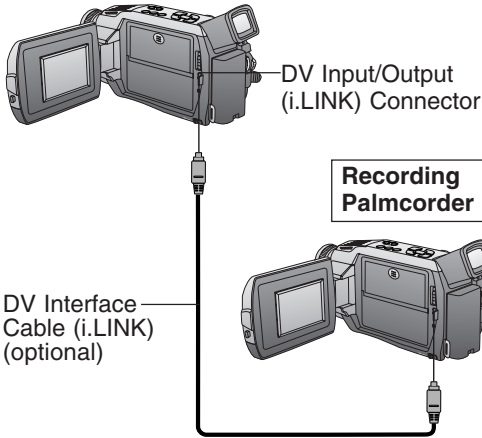

3, 4, 5 PAUSE

3, 4 PLAY

6 STOP

4 REC

Before you begin

- Connect both Palmcoders to their power sources.
- Connect the two Palmcoders using the DV Interface cable (i.LINK) (4-pin to 4-pin).
- Turn both Palmcoders ON.

- 1** Insert a pre-recorded tape into the source (playing) Palmcorder, and set **POWER to VCR**.
- 2** Insert a blank tape with the record tab closed into the target (recording) Palmcorder and set **POWER to VCR**.
- 3** Press **▶ (PLAY)** on the source Palmcorder. When the tape reaches the point you want to start dubbing, press **⏸ (PAUSE)**.
- 4** Hold down **● (REC)** and press **▶ (PLAY)** on the target (recording) Palmcorder. Press **⏸ (PAUSE)** to pause the tape at the starting point of the dub.
- 5** Simultaneously, press **⏸ (PAUSE)** on both units to begin dubbing.
- 6** Press **■ (STOP)** on the recording unit, and then press **■ (STOP)** on the playing unit to end dubbing.

CAUTION:

Unauthorized exchanging and/or copying of copyrighted recordings may be copyright infringement.

PC Connection

PC Connection with DV Interface Cable (i.LINK)

A video clip can be transferred directly to your PC (Personal Computer) via a DV Interface Cable (i.LINK) (not supplied) using products and software from a number of video editing software companies.

Using products from video editing software companies allows you to capture and edit video clips using the DV Interface (i.LINK).

Our DVC being OHCI compliant should have no problem working with any OHCI compliant Firewire Card/video - Editing software package.

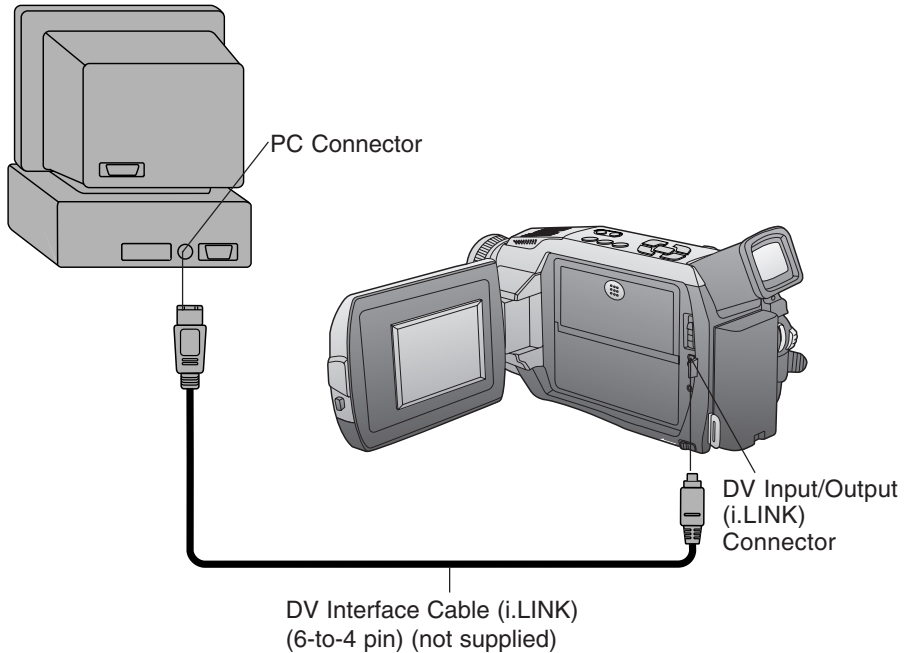

Note

- During Palmcorder playback, do not disconnect the DV Interface Cable (i.LINK) or turn the Palmcorder off as this may cause a PC hang-up error.

PHOTOVU LINK Driver (Optional)

An image recorded on the DV Tape can be transferred to your PC (Personal Computer).

System Requirements for PHOTOVU LINK Driver (Optional)

- IBM PC/AT or compatible
- Intel® Pentium® Processor
- Microsoft Windows 98/Me/2000/XP
- RAM: 16 MB or more
- 2 MB minimum available hard disk space
- 256 color monitor (full color recommended)
- 3.5 inch 1.44 MB floppy disk drive (for installation)
- RS-232C serial port (D-Sub 9-pin)
An adaptor (D-Sub 9-pin male to a D-Sub female) is required for a D-Sub 25-pin
- Mouse or other pointing device

*Satisfy the conditions recommended by Microsoft for Windows.

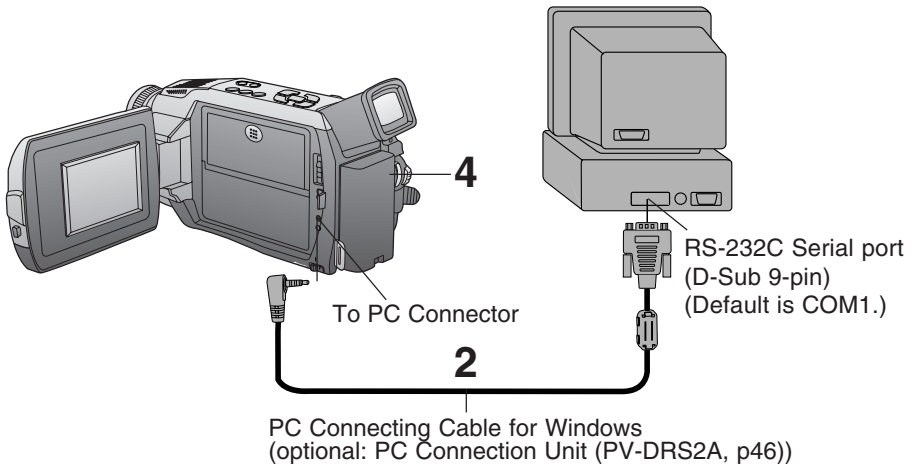

Connection

- 1** Turn off your PC.
- 2** Connect the Palmcorder to your PC (Windows) using the PC connecting cable (optional: PC Connection Unit (PV-DRS2A, p46)).
 - Before connecting the Palmcorder to the PC, make sure the PC power is off to insure that images are transferred properly.
- 3** Turn on your PC.
- 4** Set the Palmcorder POWER to VCR.

Note

- For extended periods of use, it is recommended to use the AC Adaptor as a power source.
- Refer to PC or Windows manual to identify which COM port is to be used for connection.

PHOTOVU LINK (Optional)

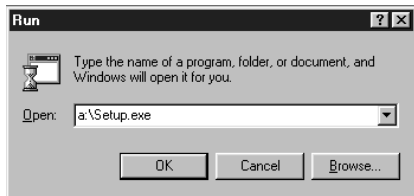
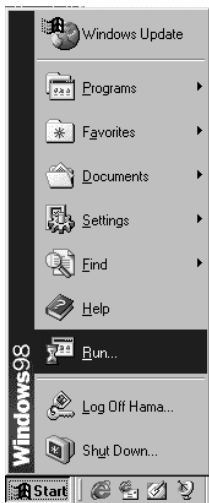

- 1 Turn your PC (Personal Computer) on and start up Windows.
- 2 Insert **PHOTOVU LINK DRIVER Disk (Optional)** into a floppy disk drive.
- 3 Click on **Start**, then **“Run...”**
- 4 Type in **“a:\setup.exe”** and click **OK**.
 - If your 3.5 inch floppy disk drive is not “A”, use the appropriate letter.
- 5 Follow the instructions as they appear on the PC screen until the installation is complete.
 - Setup window will disappear when the installation is complete.

Running the Software

PHOTOVU LINK:

You can transfer images from your Palmcorder tape to your PC.

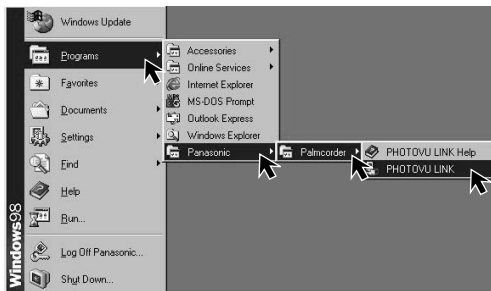

Before you begin

- Insert the Tape. (p. 9)
- Make Palmcorder-PC connections. (p. 43)
- Turn your PC on.
- Set Palmcorder POWER to VCR.

- 1 Click on **Start**, **“(All) Programs,”** **“Panasonic,”** **“Palmcorder,”** then **“PHOTOVU LINK.”**
- 2 **“PHOTOVU LINK”** is opened.

Note

- COM Port and Baudrate are automatically selected.

Refer to **Help** for information about application operations and other Error messages.

PHOTOVU LINK (Optional)

Using Tape Image Data

Pictures captured with the Palmcorder can be transferred to your PC.

Before you begin

- Insert a recorded tape. (p. 9)
- Make Palmcorder-PC connections. (p. 43)
- Turn your PC on.
- Set Palmcorder POWER to VCR.

- 1 Repeat steps 1 and 2 on page 44 to run the Software.
- 2 “Preview Window” screen appears.
- 3 **Search and Select** a still scene you want to transfer to your PC using VCR Operation Buttons on the “Preview window” screen. Then click on “**Transfer**” to transfer selected image from camcorder to “Preview Window” in PLAY or STILL mode.

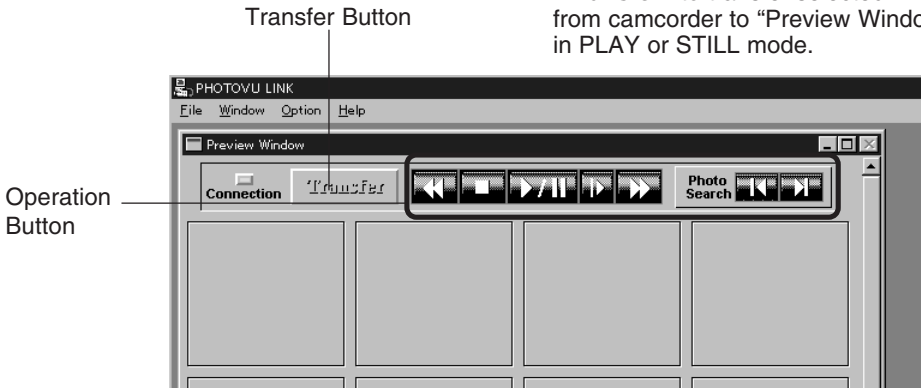

- 4 Click on “File” then “Save As”. Save transferred image to PC.

Note

- If, while transferring the image to your PC, the displayed picture appears abnormal, close PHOTOVU LINK and turn Camcorder POWER off. Run PHOTOVU LINK again and turn Palmcorder Power back on. Now transfer again.
- Photo Search may fail to detect a recorded PhotoShot image if the image is 3 seconds or less.

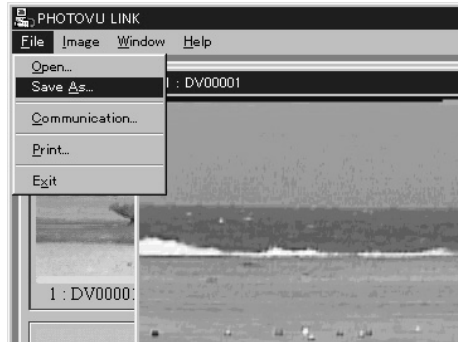

Palmcorder Accessory System

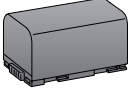
Accessory #	Figure	Description	Price
PV-DAC11A		AC Adaptor with AC Cable and DC Cable	\$119.95
CGR-D08A/1B		800mAh / 1 h 30 min, Battery Pack	\$69.95
CGR-D16A/1B		1600mAh / 3 h, Battery Pack	\$99.95
CGP-D28A/1B		2800mAh / 5 h, Battery Pack	\$129.95
CGR-D53A/1K		5300mAh / 9 h, Battery Pack	\$229.95
PV-DDC9		DV Interface Cable (i.LINK) (4-pin to 4-pin)	\$55.00
PV-DRS2A		PC Connection Unit (RS-232C Serial Kit)	Call for Pricing

Palmcorder Accessory Order Form

Please photocopy this form when placing an order.

1. Palmcorder Model # _____

2. Items Ordered

Accessory #	Description	Price Each	Quantity	Total Price
Subtotal				
Your State & Local Sales Tax				
Shipping & Handling				6.95
Total Enclosed				

3. Method of payment (check one)

- Check of Money Order enclosed (NO C.O.D.SHIPMENTS)
- VISA Credit Card # _____
- MasterCard Expiration Date _____
- Discover Customer Signature _____

Make Check or Money Order to: PANASONIC ACCESSORIES

(Please do not send cash)

4. Shipping information (UPS delivery requires complete street address)

Ship To:

Mr.

Mrs.

Ms.

First

Last

Phone #:

Day () _____

Street Address

Night () _____

City

State

Zip

TO OBTAIN ANY OF OUR PALMCORDER ACCESSORIES YOU CAN DO ANY OF THE FOLLOWING:

VISIT YOUR LOCAL PANASONIC DEALER

OR

CALL PANASONIC'S ACCESSORY ORDER LINE AT 1-800-332-5368

[6 AM-5 PM M-F, 6 AM-10:30 AM SAT, PACIFIC TIME]

OR

MAIL THIS ORDER TO: PANASONIC SERVICES COMPANY ACCESSORY ORDER OFFICE

20421 84th Avenue South Kent, WA. 98032

For Your Information

Notes On Operations

Replacing the Bulb

- 1** Insert a rigid wire, such as an extended paper clip into point (A) and lift cover up.

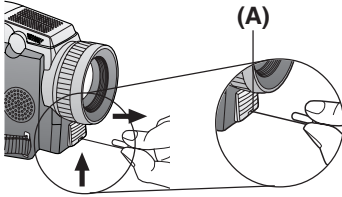

- 2** Using Tweezers or needle-nose pliers, carefully remove bulb.
- Take unit to servicenter if you need assistance.

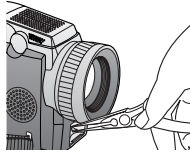

Before you begin

- Set POWER to OFF.

- 3** Replace bulb using a clean cloth or tissue. (Do not touch with fingers.)

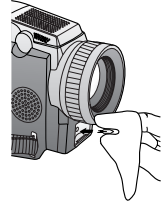

- 4** Replace lens cover.



Note

- Handle bulb gently. Excessive force may cause bulb to crack.

DANGER:

Use only replacement bulb (PART NO. LSL0028) supplied by Panasonic to reduce risk of fire. Handle new bulb with cloth or tissue as skin oils decrease bulb life. Remove lens cover and allow bulb to cool before replacing to avoid possible burn hazard.

Notice

This product has a fluorescent lamp that contains a small amount of mercury. It also contains lead in some components. Disposal of these materials may be regulated in your community due to environmental considerations. For disposal or recycling information please contact your local authorities, or the Electronics Industries Alliance: <<http://www.eiae.org>.>

Notes On Operations

Approximate Brightness Values

Your Palmcorder has been designed for normal scene illumination of 150 footcandles (1500 lx). However, the Palmcorder may be used at F1:1.8, if illumination is more than 0.5 footcandles (5 lx).

The table below shows the color temperature for reference.

PALMCORDER SETTINGS	NATURAL LIGHT CONDITIONS	KELVIN COLOR TEMPERATURE	ARTIFICIAL LIGHT SOURCE	COLOR TINT MIXTURE
	<ul style="list-style-type: none"> Fair weather, blue sky 	— 10,000	<ul style="list-style-type: none"> Color television 	Bluish
	<ul style="list-style-type: none"> Slightly cloudy sky 	— 8,000	<ul style="list-style-type: none"> Fluorescent lamp (Daylight) Camera flash bulb 	
	<ul style="list-style-type: none"> Cloudy or rainy sky 	— 7,000		
	<ul style="list-style-type: none"> Sunlight in clear weather at midday 	— 6,000		
	<ul style="list-style-type: none"> Average sunlight in clear weather 	— 5,500	<ul style="list-style-type: none"> Blue lamp for photography 	
	<ul style="list-style-type: none"> Sunlight 2 hours after sunrise and before sunset 	— 5,000		
	<ul style="list-style-type: none"> Sunlight 40 min. after sunrise and before sunset 	— 4,500	<ul style="list-style-type: none"> Fluorescent lamp (White) Normal flash bulb Fluorescent lamp (Off-white) Tungsten lamp for photography 	Whitish
	<ul style="list-style-type: none"> Sunlight 30 min. after sunrise and before sunset 	— 4,000		
	<ul style="list-style-type: none"> Sunlight 20 min. after sunrise and before sunset 	— 3,500		
		— 3,200	<ul style="list-style-type: none"> Halogen lamp Iodine lamp 	
		— 2,800		
		— 2,000	<ul style="list-style-type: none"> Tungsten lamp Acetylene lamp Kerosene lamp Candlelight 	<ul style="list-style-type: none"> Yellowish Reddish

Specifications

Power Source:	Palmcorder: 7.2 V DC (Battery) 7.8 V DC (AC Adaptor) AC Adaptor: 110/120/220/240 V AC, 50/60 Hz Battery: Lithium-Ion Type DC 7.2 V
Power Consumption:	Palmcorder : 7.2 V/7.8 V DC 6.5 W (Max. 9.5 W) AC Adaptor : 18 W 1 W (when not in use.)
Digital Interface	i.LINK (IEEE1394)
Video Signal:	EIA Standard (525 lines, 60 fields) NTSC color signal
Video Recording System:	2 rotary heads. helical scanning system
Audio:	12 bit (32 kHz) 4 tracks 16 bit (48 kHz) 2 tracks
Pick-Up System and Device:	One integral color filter Charge Coupled Device (CCD)
Lens:	10:1 zoom lens, F1:1.8 with auto iris control Focal length: 3.6 mm - 36 mm Power zoom function Lens filter diameter: 43 mm
Viewfinder:	6.0 mm (0.24 inch) Electronic Viewfinder
LCD Monitor:	63.5 mm (2.5 inch) Liquid Crystal Display
Minimum Illumination Required:	5 lx (F1:1.8) 0.5 footcandles
Operating Temperature:	32 °F~104 °F (0 °C~40 °C)
Operating Humidity:	10 %~75 %
Weight:	Palmcorder: 0.58 kg 1.28 lbs. AC Adaptor: 0.16 kg 0.35 lbs.
Dimensions:	Palmcorder: 74 (W) x 88.5 (H) x 182 (D) mm 2-7/8 (W) x 3-1/2 (H) x 7-1/8 (D) inch AC Adaptor: 70 (W) x 45 (H) x 115 (D) mm 2-3/4 (W) x 1-3/4 (H) x 4-1/2 (D) inch

Weight and dimensions shown are approximate.
Designs and specifications are subject to change without notice.

Before Requesting Service

Cleaning Care for Video Heads

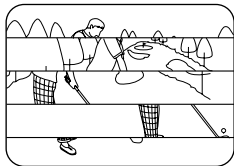

Clogged Video Head

(a) Video Head Cleaning: Normally, your Palmcorder will not require head cleaning. However, it is possible that the heads may become clogged due to dust in the air, playing damaged tapes, long term use, etc. If "NEED HEAD CLEANING" appears for 5 seconds in the EVF or LCD monitor, the heads may require cleaning.

(b) Cleaning the Heads: It is recommended that head cleaning be performed by a qualified service technician. Please contact your nearest Panasonic Servicenter. An alternate solution is to obtain a head cleaning cassette. Please use Panasonic cleaning cassette (AY-DVMCLA). Be sure to follow the cleaning instructions carefully. Excessive use of the head cleaning cassette could shorten video head life.

Use this cassette only when a head clogging symptoms occur.

Refer servicing to qualified service personnel.

Tape Operations Caution

- When you go from function to function (PLAY, FF, REW etc.), please note that the unit will not accept a new function operation until the previous operation is complete.
- The POWER Button and all function buttons, (PLAY, FF, REW, etc.) are only operational after the tape has been completely loaded.

Lens Hood Area Operation Caution

When the following accessories are attached and the zoom is set to maximum wide angle, the four corners of the scene may appear darker:

- Wide or Telephoto conversion lens (optional).
- A filter (optional), etc. and then the lens hood.
- Two filters (optional).

Before Requesting Service

If you have a problem with your Palmcorder, it may be something you can correct yourself. Check the list below for symptoms and corrections.

Symptom	Correction
No picture in the EVF or LCD Monitor...	<ul style="list-style-type: none"> • Make sure the Power Source is connected. (pp. 11, 12) • Make sure the POWER switch is set to VCR or CAMERA. (pp. 15, 27) • Check the Dew Indicator. (p. 53) • Make sure the Battery is fully charged. (p. 11) • Make sure all necessary cables are connected correctly and firmly. (p. 12) • Make sure the Lens Cap is removed. (p. 15)
Video cassette cannot be inserted...	<ul style="list-style-type: none"> • Make sure the Power Source is connected. (pp. 11, 12) • Insert the cassette record tab up, window side facing out. (p. 9)
Video cassette cannot be removed...	<ul style="list-style-type: none"> • Make sure the Power source is connected. (pp. 11, 12)
No operation starts when operation buttons are pressed...	<ul style="list-style-type: none"> • Check the Dew Indicator. (p. 53)
Recording cannot be done...	<ul style="list-style-type: none"> • Make sure the record tab is closed. (p. 6) • Check the Battery Indication. (p. 63)
Auto Focus does not operate...	<ul style="list-style-type: none"> • Make sure FOCUS is set to AUTO. (p. 24) • Make sure the unit is ON and set to CAMERA mode. (p. 15)
Sound from microphone cannot be monitored...	<ul style="list-style-type: none"> • Make sure the unit is set to REC or REC/PAUSE mode. (p. 15)
Sound cannot be heard...	<ul style="list-style-type: none"> • Make sure the Audio on the VCR MENU is set to ST1. (pp. 38, 61)

Request for Service Notice

Please photocopy this form when making a request for service notice.

Request for Service Notice:





In the unlikely event this product needs service.

- Please include your **proof of purchase**. (Failure to do so will delay your repair.)
- To further speed your repair, please provide an explanation of what is wrong with the unit and any symptom it is exhibiting.

Mail this completed form and your Proof of Purchase along with your unit to:
 Panasonic Services Company
 1705 N. Randall Road
 Elgin, IL. 60123-7847
 Attn: Camcorder Repair

On-Screen Displays (OSD)

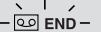
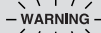
The following warning displays appear in the EVF and the LCD monitor.

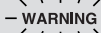
Indications	Condition
 TAPE NOT INSERTED	If the Palmcorder is in CAMERA mode without a cassette inserted, "□□" will flash and "TAPE NOT INSERTED" will appear for 5 seconds. Recording will not start.
 CHECK REC TAB	If the Palmcorder is in CAMERA mode or Audio dub mode with the cassette sliding record tab opened, "□□" will flash and "CHECK REC TAB" will appear for 5 seconds. Recording will not start.
 CANNOT REC	When Audio dub is performed and recording is other than NTSC format, "□□" will flash and "CANNOT REC" will appear for 5 seconds.
 TAPE END	When the tape is about to end in REC mode, "□□ END" will flash and "TAPE END" will appear for 5 seconds.
INCOMPATIBLE TAPE	When an incompatible tape is detected, "INCOMPATIBLE TAPE" will appear for 5 seconds.
NEED HEAD CLEANING	If the video heads require cleaning, "NEED HEAD CLEANING" will appear for 5 seconds.
CANNOT REC LP-MODE	When an AUDIO DUB is attempted on a pre-recorded LP tape, "CANNOT REC LP-MODE" will appear for 5 seconds.
 DEW DETECTED	If excessive moisture condenses in the unit, "WARNING" will flash, "DEW DETECTED" will appear, and the Palmcorder will automatically turn OFF in 15 seconds. In this case, wait until the indicator no longer flashes when your Palmcorder is turned ON again.
  LOW BATTERY	When a battery recharge is necessary, "WARNING" will flash, "LOW BATTERY" will appear, and the Palmcorder will automatically turn OFF in 15 seconds. (p. 63)
CLOCK BATTERY	When the built-in lithium clock battery is discharged, "CLOCK BATTERY" will appear. To re-charge the lithium clock battery, connect the AC Adaptor to the Palmcorder. Recharging takes approx. 4 hours. Reset the clock after charging.
INCOMPATIBLE DATA	If you play a tape recorded in a format other than NTSC or you try to copy copy-protected data, "INCOMPATIBLE DATA" will appear.

Limited Warranty

PANASONIC CONSUMER ELECTRONICS COMPANY,
DIVISION OF MATSUSHITA ELECTRIC
CORPORATION OF AMERICA
One Panasonic Way Secaucus, New Jersey 07094

PANASONIC SALES COMPANY, DIVISION OF MATSUSHITA
ELECTRIC OF PUERTO RICO, INC.,
AVE. 65 de Inifertería, Km. 9.5 San Gabriel Industrial Park,
Carolina, Puerto Rico 00985

Panasonic/Quasar Video Products Limited Warranty

Limited Warranty Coverage

If your product does not work properly because of a defect in materials or workmanship, Panasonic Consumer Electronics Company or Panasonic Sales Company (collectively referred to as "the warrantor") will, for the length of the period indicated on the chart below, which starts with the date of original purchase ("warranty period"), at its option either (a) repair your product with new or refurbished parts, or (b) replace it with a new or a refurbished product. The decision to repair or replace will be made by the warrantor.

Product	Parts	Labor	Service	Contact Number
Camcorder	One (1) Year (except CCD Image Sensor) CCD Image Sensor - 6 (Six) Months	Ninety (90) Days Ninety (90) Days	Carry-In or Mail-In	1-800-211-PANA(7262)
DVD/VCR Deck, A/V Mixer	One (1) Year	Ninety (90) Days	Carry-In or Mail-In	1-800-211-PANA(7262)
TV/VCR, TV/DVD, TV/DVD/VCR Combination	One (1) Year (except CRT) CRT - Two (2) Years	Ninety (90) Days Ninety (90) Days	Carry-In: 21" CRT and Smaller In-Home or Carry-In: 22" CRT and Larger	1-800-211-PANA(7262)
TV/HDR Combination	One (1) Year (except CRT) CRT - Two (2) Years	Ninety (90) Days Ninety (90) Days	In-Home or Carry-In	1-888-843-9788
Rechargeable Batteries (in exchange for defective item)	Ten (10) Days	Not Applicable	Carry-In or Mail-In	1-800-211-PANA(7262)
Tape (in exchange for defective item)	Five (5) Days	Not Applicable	Carry-In or Mail-In	1-800-211-PANA(7262)
Memory Cards (in exchange for defective item)	Ninety (90) Days	Not Applicable	Carry-In or Mail-In	1-800-211-PANA(7262)

During the "Labor" warranty period there will be no charge for labor. During the "Parts" warranty period, there will be no charge for parts. You must carry-in or mail-in your product or arrange for in-home service, as applicable, during the warranty period. If non-rechargeable batteries are included, they are not warranted. This warranty only applies to products purchased and serviced in the United States or Puerto Rico. This warranty is extended only to the original purchaser of a new product which was not sold "as is". A purchase receipt or other proof of the original purchase date is required for warranty service.

Carry-In, Mail-in or In-Home Service

For Carry-In, Mail-In or In-Home Service (as applicable) in the United States call toll free contact number listed above or visit Panasonic Web Site: <http://www.panasonic.com>

For assistance in Puerto Rico call Panasonic Sales Company (787)-750-4300 or fax (787)-768-2910.

In-Home service, if applicable, requires clear, complete and easy access to the product by the authorized servicer and does not include removal or re-installation of an installed product. It is possible that certain in-home repairs will not be completed in-home, but will require that the product, or parts of the product, be removed for shop diagnosis and/or repair and then returned.

Limited Warranty Limits And Exclusions

This warranty ONLY COVERS failures due to defects in materials or workmanship, and DOES NOT COVER normal wear and tear or cosmetic damage, nor does it cover markings or retained images on the picture tube resulting from viewing fixed images (including, among other things, letterbox pictures on standard 4:3 screen TV's, or non-expanded standard 4:3 pictures on wide screen TV's, or onscreen data in a stationary and fixed location). The warranty ALSO DOES NOT COVER damages which occurred in shipment, or failures which are caused by products not supplied by the warrantor, or failures which result from accidents, misuse, abuse, neglect, mishandling, misapplication, alteration, faulty installation, set-up adjustments, misadjustment of consumer controls, improper maintenance, power line surge, lightning damage, modification, or commercial use (such as in a hotel, office, restaurant, or other business), rental use of the product, service by anyone other than a Factory Servicenter or other Authorized Servicer, or damage that is attributable to acts of God.

THERE ARE NO EXPRESS WARRANTIES EXCEPT AS LISTED UNDER "LIMITED WARRANTY COVERAGE". THE WARRANTOR IS NOT LIABLE FOR INCIDENTAL OR CONSEQUENTIAL DAMAGES RESULTING FROM THE USE OF THIS PRODUCT, OR ARISING OUT OF ANY BREACH OF THIS WARRANTY. (As examples, this excludes damages for lost time, cost of having someone remove or re-install an installed unit if applicable, or travel to and from the servicer, loss of media or images, data or other memory or recorded content. The items listed are not exclusive, but are for illustration only.)

ALL EXPRESS AND IMPLIED WARRANTIES, INCLUDING THE WARRANTY OF MERCHANTABILITY, ARE LIMITED TO THE PERIOD OF THE LIMITED WARRANTY.

Some states do not allow the exclusion or limitation of incidental or consequential damages, or limitations on how long an implied warranty lasts, so the exclusions may not apply to you.

This warranty gives you specific legal rights and you may also have other rights which vary from state to state. If a problem with this product develops during or after the warranty period, you may contact your dealer or Servicenter. If the problem is not handled to your satisfaction, then write to the warrantor's Consumer Affairs Department at the addresses listed for the warrantor.

PARTS AND SERVICE (INCLUDING COST OF AN IN-HOME SERVICE CALL, WHERE APPLICABLE) WHICH ARE NOT COVERED BY THIS LIMITED WARRANTY ARE YOUR RESPONSIBILITY.

Customer Services Directory

For Product Information, Operating Assistance, Literature Request, Dealer Locations, and all Customer Service inquiries please contact:
1-800-211-PANA (7262), Monday-Friday 9 am-9 pm; Saturday-Sunday 9 am-7 pm, EST.
or send e-mail : consumerproducts@panasonic.com
For hearing or speech impaired TTY users, TTY: 1-877-833-8855

Web Site: <http://www.panasonic.com>
You can purchase parts, accessories or locate your nearest servicer by visiting our Web Site.

Accessory Purchases:

1-800-332-5368 (Customer Orders Only)
For hearing or speech impaired TTY users, TTY: 1-866-605-1277
Panasonic Services Company 20421 84th Avenue South, Kent, WA 98032
(Monday-Friday 6 am-5 pm; Saturday 6 am-10:30 am, PST)
(Visa, MasterCard, Discover Card, American Express, Check)

Product Repairs

Centralized Factory Servicer

MAIL TO : Panasonic Services Company
1705 N. Randall Road,
Elgin, IL 60123-7847
Attention: Camcorder Repair

Please carefully pack and ship, prepaid and insured, to the Elgin Centralized Factory Servicer.
Customer's in Puerto Rico, please ship or carry in to location below ("Service in Puerto Rico").

Service in Puerto Rico

Matsushita Electric of Puerto Rico, Inc. Panasonic Sales Company/ Factory Servicer:
Ave. 65 de Infanteria. Km. 9.5, San Gabriel Industrial Park, Carolina, Puerto Rico 00985
Phone (787) 750-4300 Fax (787) 768-2910

As of August 2002

Spanish Quick Use Guide/Guía Para Uso Rápido

Precauciones para su seguridad

ADVERTENCIA: PARA EVITAR INCENDIOS Y DESCARGAS ELÉCTRICAS, NO EXPONGA ESTE EQUIPO A LA LLUVIA NI A LA HUMEDAD.

Su Mini DV Palmcorder está diseñada para grabar y reproducir en el modo de Reproducción Estándar (SP) y modo Largo (LP).

Se recomienda el uso sólo de cintas de cassette que hayan sido probadas e inspeccionadas para su uso en aparatos VCR con la marca Mini DV.

 PRECAUCIÓN RIESGO DE DESCARGA ELÉCTRICA NO ABRIR 	 <p>Este símbolo tiene por finalidad alertar al usuario acerca de la presencia de tensión sin aislación en el interior del producto, que puede tener la intensidad suficiente como para causar descargas eléctricas. Por lo tanto, hacer contacto con cualquier pieza en el interior de la unidad es peligroso.</p>
<p>PRECAUCIÓN: PARA REDUCIR EL RIESGO DE DESCARGA ELÉCTRICA, NO quite LA CUBIERTA (O PARTE POSTERIOR). EL APARATO NO TIENE EN SU INTERIOR PIEZAS QUE PUEDAN SER REPARADAS POR EL USUARIO. SOLICITE TODA REPARACIÓN A PERSONAL DE SERVICIO CUALIFICADO.</p>	 <p>Este símbolo tiene por finalidad alertar al usuario de la presencia de importantes instrucciones de operación y mantenimiento en la literatura incluida con la unidad. Por lo tanto, lea detenidamente la literatura incluida para evitar problemas.</p>

La etiqueta de régimen está pegada en la base de la cubierta del cargador.

Este dispositivo cumple con la parte 15 de las Reglas del FCC. El funcionamiento está sujeto a las dos siguientes condiciones: (1) Este dispositivo puede no causar interferencias perjudiciales, y (2) este dispositivo debe aceptar cualquier interferencia recibida, incluyendo interferencias que pueden causar un funcionamiento no deseado.

Nota: Este equipo ha sido puesto a prueba y se encontró que cumple con la Parte 15 de las reglas del FCC. Estos límites están diseñados para proveer una protección razonable contra interferencias cuando se opera en un ambiente residencial.

Si este equipo causa interferencias en la recepción de radio o televisión, lo cual se puede comprobar al apagar y encender el equipo, utilice el equipo en otra ubicación y/o utilice un tomacorriente diferente al que está utilizando el receptor. Si es necesario, consulte con el distribuidor o un técnico experto de radio/TV para solicitar ayuda. Puede encontrar útil el folleto 'Información sobre las interferencias' disponible en las oficinas regionales del FCC local.

Advertencia del FCC:

Para asegurar la conformidad continua del FCC, utilice solamente el cable de interfaz blindado cuando conecte una cámara de video digital a una computadora de acuerdo con las instrucciones incluidas aquí. También, cualquier cambio sin autorización o modificaciones a este equipo anularían la autoridad del usuario para operarlo.

Spanish Quick Use Guide/Guía Para Uso Rápido

Inserte de la batería

Antes de comenzar

- Cargue la batería. (Página 11.)

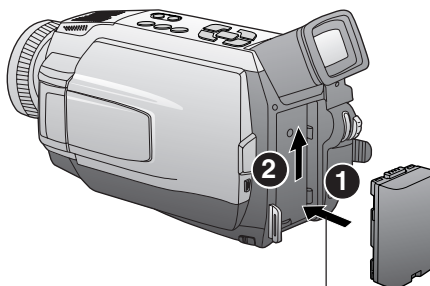

- 1** Coloque la batería y deslícela hacia arriba hasta que se quede bloqueada con un clic.

Inserte el Cassette

Esta videocámara contiene un sistema de ejecución fácil del cassette. Por eso, es fácil de introducir o sacar el cassette aunque esté montado sobre un trípode. (Página 7.)

- 1** Presione LCD-OPEN y abra completamente el monitor LCD.

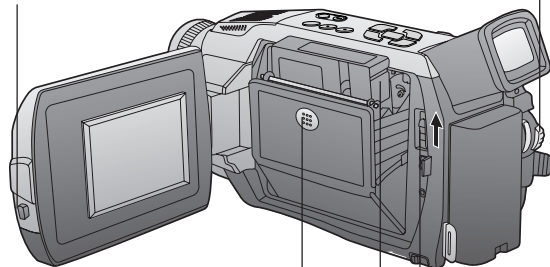

- 2** Ajuste el interruptor de alimentación (POWER) a la posición VCR o CAMERA.

- 3** Deslice el interruptor de expulsión de cinta (TAPE EJECT) para abrir la tapa del compartimento del cassette.

- 5** Presione la marca PUSH CLOSE (EMPUJAR PARA CERRAR) para cerrar la tapa del compartimento del cassette.

- 4** Introduzca un cassette con la parte de la ventana hacia arriba.
 - Asegúrese de que la lengüeta de grabación esté cerrada. (Página 6.)

Spanish Quick Use Guide/Guía Para Uso Rápido

Grabación con la cámara

Cuando el monitor LCD se encuentra totalmente abjerto, el visor se DESACTIVA automáticamente.

- 1** Ajuste el interruptor de alimentación (POWER) a la posición CAMERA.

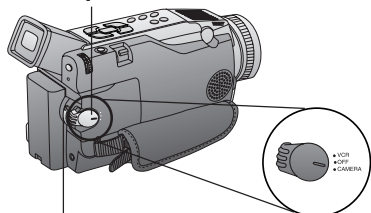

- 2** Ajuste el control de ajuste de visión según lo desee.

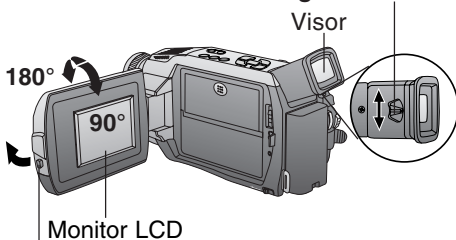

- 4** Presione el botón de grabación/pausa (REC/PAUSE) para iniciar la grabación. Vuelva a pulsar el botón de grabación/pausa (REC/PAUSE) para hacer una pausa en la grabación.

- 3** Presione el botón de apertura del LCD (LCD-OPEN) para desbloquear el monitor LCD. Balancée abriéndolo completamente y ajuste el ángulo.

Para ver la reproducción en el LCD (pantalla de visualización de cristal líquido)

Cuando el monitor LCD se encuentra totalmente abierto, el visor se DESACTIVA automáticamente.

Antes de comenzar

- Cargue la batería. (Página 11.)

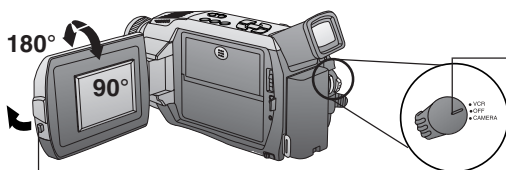

- 2** Presione el botón de apertura del LCD (LCD-OPEN) para desbloquear el monitor LCD. Balancée abriéndolo completamente y ajuste el ángulo.

- 3** Presione el botón de rebobinado ◀◀ (REW) para rebobinar la cinta.

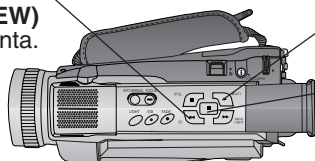

- 1** Ajuste el interruptor de alimentación (POWER) a la posición VCR.

- 4** Presione el botón de reproducción ▶ (PLAY) para reproducir la cinta.

- 5** Presione el botón de parada ■ (STOP) para detener la reproducción.

Camera Mode Menu Screen

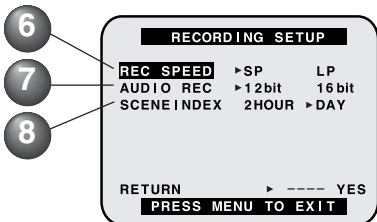
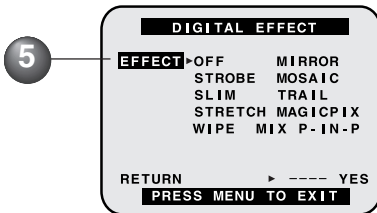
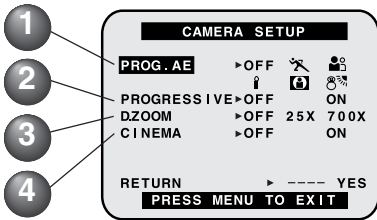

- 1** **PROG. AE** (p. 21)
To select one of the 5 Program AE modes. Setting to OFF cancels the previously selected Program AE mode.
- 2** **PROGRESSIVE** (p. 17)
When set to ON, still pictures taken with PhotoShot are recorded with a higher resolution than with normal PhotoShot.
- 3** **D. ZOOM** (p. 33)
To select 25X (from 10X to 25X) or 700X (from 10X to 700X). Setting to OFF cancels the previously selected digital zoom.
- 4** **CINEMA** (p. 20)
When set to ON, you can record a picture compatible with a wide-screen TV equipped with an S2 picture terminal.
- 5** **EFFECT** (pp. 34, 36)
To select one of the 10 digital functions. Setting to OFF cancels the previously selected digital function.
- 6** **REC SPEED** (pp. 6, 15)
SP: Normal recording speed mode.
LP: Recording time is 1.5 times as long as in the SP mode. For example, 120 minutes of recording is possible on a 80 minute tape.
- 7** **AUDIO REC** (p. 38)
12 bit: The sound is recorded in the 12 bit/32 kHz mode.
16 bit: The sound is recorded in the 16 bit/48 kHz high-quality mode.
- 8** **SCENEINDEX (REC Only)**
DAY: An index signal is recorded when recording is restarted after the date has changed since the last recording.
2 HOUR: An index signal is recorded when recording is restarted after a lapse of more than 2 hours.

MENU OSD

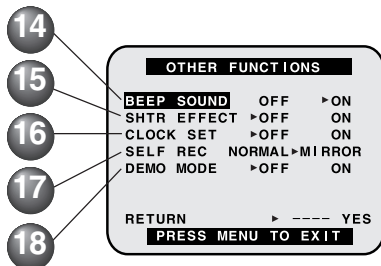
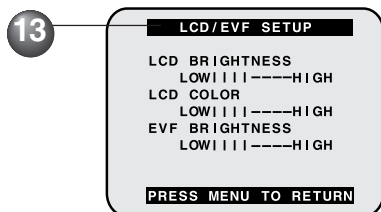
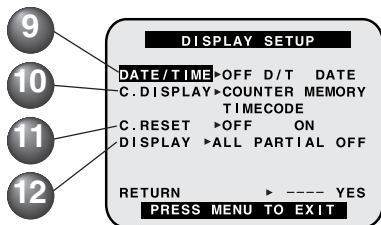

- 9 DATE/TIME** (p. 64)
The date and time can be set and displayed on the screen.
- 10 C. DISPLAY** (p. 63)
To select the desired type of counter indication displayed on the LCD Monitor or in the viewfinder.
- 11 C. RESET** (p. 63)
Setting to ON resets the counter to zero.
- 12 DISPLAY** (p. 63)
To select the desired type of display changes to all function display, Partial display, and Minimum display.
- 13 LCD/EVF SETUP** (p. 16)
Setting to ON displays the menu for adjusting the LCD brightness, color level, and the EVF brightness.
- 14 BEEP SOUND**
Set to ON to hear beep when starting and stopping camera recording or when unusual conditions occur. To cancel the beep, set to OFF.
Palmcorder will beep:
Once when you start recording
Twice when you stop recording
Repeatedly when warning of unusual conditions. (p. 53)
- 15 SHTR EFFECT** (p. 17)
When set to ON, still pictures taken in the PhotoShot mode are recorded with a visual shutter effect and click sound.
- 16 CLOCK SET** (p. 13)
When set to ON, the date and time can be set on the screen.
- 17 SELF REC** (p. 19)
NORMAL: During self-recording, the picture on the LCD Monitor is the same as it will be recorded.
MIRROR: During self-recording, the picture on the LCD Monitor is horizontally reversed.
- 18 DEMO MODE** (p. 8)
When set to ON, Self Demo starts.

VCR Mode Menu Screen

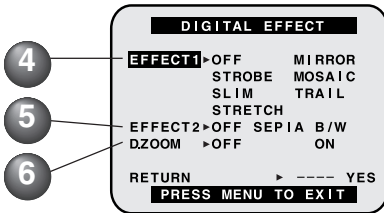
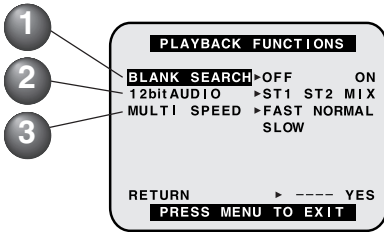

- 1 **BLANK SEARCH** (p. 28)
Select ON to go directly to a blank portion of the tape.
- 2 **12bit AUDIO** (p. 39)
To select the desired audio playback mode after performing audio dubbing in the 12 bit mode (SP mode only).
ST1 : The original sound alone is played back.
ST2 : The dubbed sound alone is played back.
MIX : The original sound and the dubbed sound are played back together.
- 3 **MULTI SPEED** (p. 31)
In Strobe Multi mode, used to select the interval at which a succession of still screens are captured from the playback picture.
FAST : Every 0.3 seconds
NORMAL : Every 0.6 seconds
SLOW : Every 1.0 seconds
- 4 **EFFECT1** (p. 36)
To select one of the 6 digital functions. Setting to OFF cancels the previously selected digital function.
- 5 **EFFECT2** (p. 36)
To select one of the 2 digital picture effects for playback. Setting to OFF cancels the previously selected digital effect.
- 6 **D. ZOOM** (p. 34)
Set to ON to double the size of a playback image. Setting to OFF cancels the previously selected digital zoom.

MENU OSD

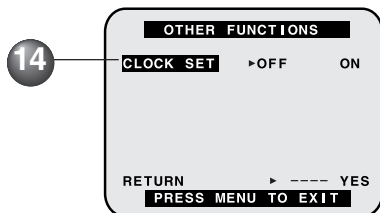
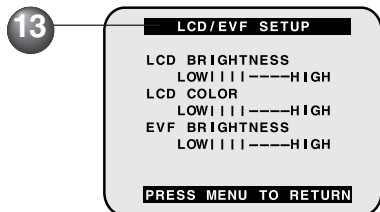
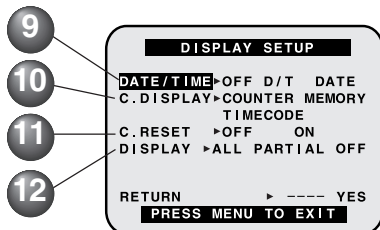
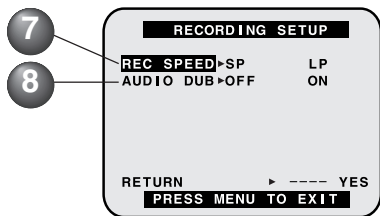

- 7 REC SPEED** (p. 6)
SP: Normal recording speed mode.
LP: Recording time is 1.5 times as long as in the SP mode. For example, 120 minutes of recording is possible on an 80 minute tape.
- 8 AUDIO DUB** (p. 38)
Set to AUDIO DUB "ON" in the Menu OSD to use the Audio Dub feature.
- 9 DATE/TIME** (p. 64)
The date and time can be set and displayed on the screen.
- 10 C. DISPLAY** (p. 63)
To select the desired type of counter indication displayed on the LCD Monitor or in the viewfinder.
- 11 C.RESET** (p. 63)
Setting to ON resets the counter to zero.
- 12 DISPLAY** (p. 63)
To select the desired type of display changes to all function display, Partial display, and Minimum display.
- 13 LCD/EVF SETUP** (p. 16)
Setting to ON displays the menu for adjusting the LCD brightness, color level, and the EVF brightness.
- 14 CLOCK SET** (p. 13)
When set to ON, the date and time can be set on the screen.

Electronic Viewfinder/LCD Monitor Indications

Here are some of the basic indications which will appear on the Palmcorder EVF and LCD Monitor. Only Date and Time indications will be recorded onto the tape.

CAMERA/VCR Mode

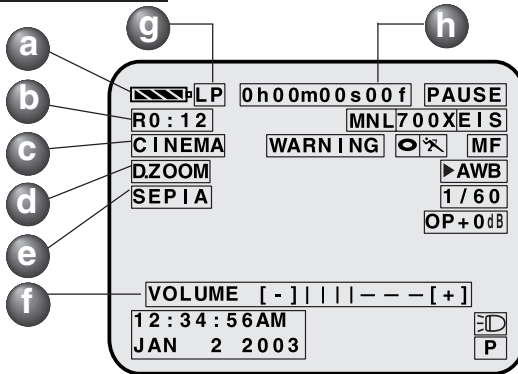

a Battery Remaining

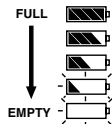

b Tape Remaining

(AY-DVM30EJ) (AY-DVM60EJ)

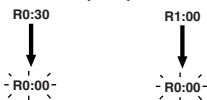

- It will take several seconds for the tape remaining indicator to operate after the tape starts moving.

c CINEMA Indication

(Menu OSD: p. 59)

d Digital Zoom and other Digital Functions

(Menu OSD: p. 59)
This display appears when the digital zoom function has been activated.

e Playback Effect

(Menu OSD: p. 61)
This display appears when SEPIA or B/W is selected in VCR menu.

f Volume Display

(p. 28)
The volume bar appears when the volume of the built-in speaker is being adjusted.

g Tape Speed Indication

(Menu OSD: p. 59)
Indicates the tape speed (SP or LP).

h Counter/Time Code

The indication switches as shown below when the desired "C. DISPLAY" mode is selected from the menu. (Menu OSD: pp. 60, 62)

Linear Time Counter

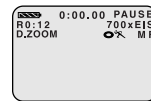

Memory Counter

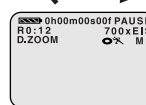
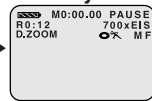

Time Code

Memory Counter M 0:00.00

The Palmcorder will stop whenever it reaches the point where the counter was previously set to M 0:00.00 during audio dub, fast forward, or rewind.

Time Code 0h00m00s00f

The Palmcorder calculates and displays exactly where you are on any tape in terms of hours, minutes, seconds, and frames (30 frames = 1 second).

- This display cannot be reset.

IMPORTANT NOTE:

- Display must be set to ALL for MF, AE, W.BALANCE or BACK LIGHT indications to be displayed on the EVF or LCD Panel when selected.
- C.RESET does not work when C. DISPLAY is set to T.CODE.

Electronic Viewfinder/LCD Monitor Indications

CAMERA/VCR Mode

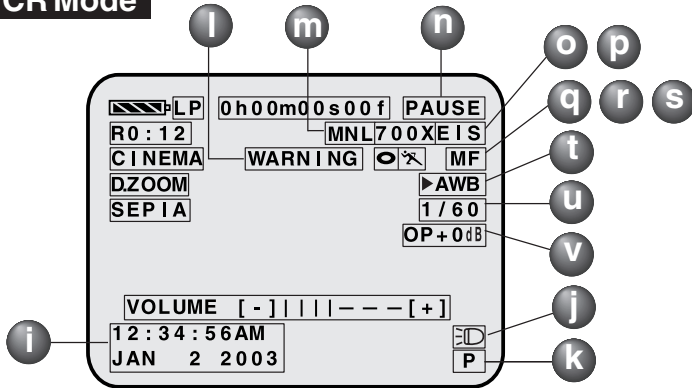

i Date and Time Indication (Menu OSD: pp. 60, 62)

As shown below, the date and time indication changes each time DATE/TIME is selected from the Palmcorder's MENU (Menu OSD: pp. 60, 62).

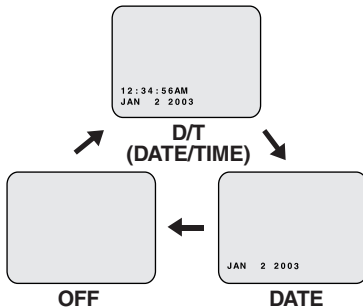

j Light Indication (p. 8) This display appears when LIGHT is set to ON.

k Progressive Indication (Menu OSD: p. 59) This display appears when PROGRESSIVE is set to ON.

l WARNING Indication (p. 53) The warning displays appear in the EVF and the LCD monitor.

m MNL Indication (pp. 23~26) This display appears when AUTO/MANUAL is pressed to MANUAL.

- ### **n** Tape Mode Indications
- REC** Recording.
 - PHOTO** PhotoShot recording.
 - PAUSE** Paused during recording.
 - ▷** Playback.
 - ||** Still.
 - ▷▷** Slow (forward).
 - ◁◁** Slow (reverse).
 - |||▷** Frame Advance (forward).
 - ◁|||** Frame Advance (reverse).
 - R▷** Repeat Playback.
 - CHK** Recording Check.
 - FF** Fast forward.
 - REW** Rewind.
 - ▷▷▷** FF Search.
 - ◁◁◁** REW Search.
 - BLANK** Blank Search.
 - SEARCH** Index Search.

o Zoom Magnification Level (p. 33)

p Digital EIS Indications (p. 35)

q Backlight Indication (p. 20)

r PROGRAM-AE Indication (p. 21)

s Manual Focus Indication (p. 24)

t White Balance Indication (p. 23)

u Shutter Mode Indication (p. 25)

v Iris Indication (p. 26)

Index of Controls

Front View

Built-in
Microphone

Lens

Built-in Light
pp. 8, 48.

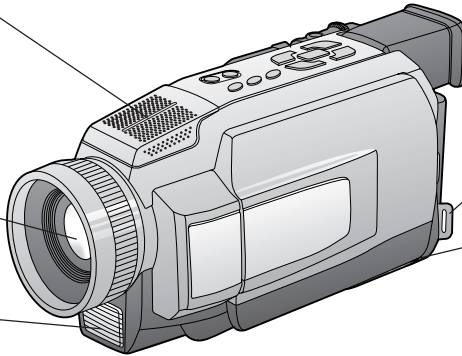

Shoulder Strap
Attachment Ring
p. 7.

BATT RELEASE
pp. 11, 12.

Side View

JOG KEY
pp. 13, 14.
M.FOCUS DIAL
p. 24.

POWER
(VCR•OFF•CAMERA)
pp. 9, 10.

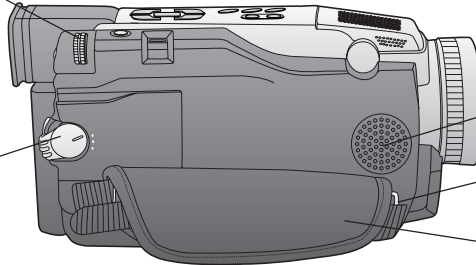

Built-in Speaker
p. 28.

Shoulder Strap
Attachment Ring
p. 7.

Hand Strap
p. 7.

Rear View

Cassette
Compartment
Cover
p. 7.

LCD (Liquid
Crystal Display)
Monitor
pp. 9, 10, 16, 27.

LCD-OPEN
pp. 9, 10, 16, 27.

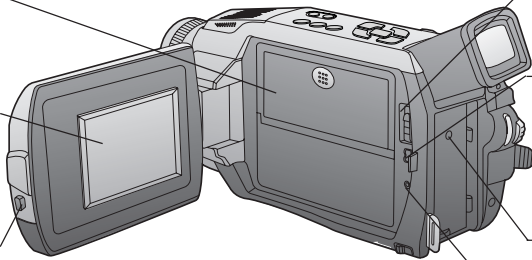

TAPE EJECT
pp. 7, 9.

DV Input/Output
(i.LINK) Connector
pp. 41, 42.

DC IN Terminal
p. 12.

PC Connector
p. 43.

Index of Controls

Rear View

Electronic Viewfinder (EVF)
p. 10.

MENU
pp. 13, 14.

A/V Output Connector
p. 32.

PHONE Jack
p. 27.

PHOTOSHOT
p. 17.

POWER ZOOM
pp. 18, 33.
VOLUME
p. 28.

Lens Cap
p. 7.

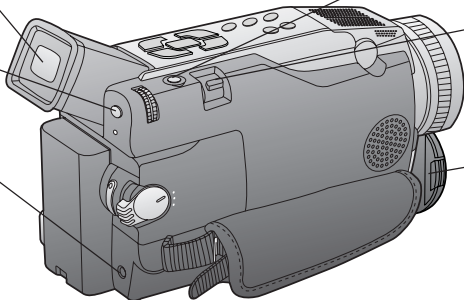

Top View

FOCUS
p. 24.

AUTO/MANUAL
pp. 23~26.

FADE
p. 22.
REC
p. 41.

LIGHT
p. 8.

EIS
p. 35.

REW
pp. 10, 27.
RECORDING CHECK
p. 18.

PAUSE
pp. 29, 39, 41.
CAMERA STILL
p. 37.

PLAY
pp. 10, 27.
MULTI
p. 31.

STOP
pp. 10, 27.

FF
p. 29.
BACK LIGHT
p. 20.

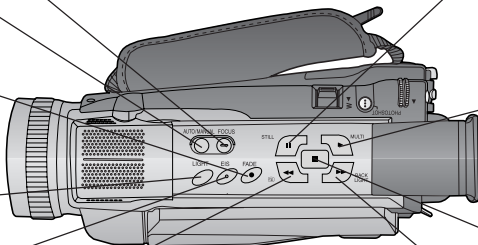

Back View

Vision Adjustment Control
pp. 10, 15.

POWER Lamp
p. 15.

REC/PAUSE
pp. 10, 15.

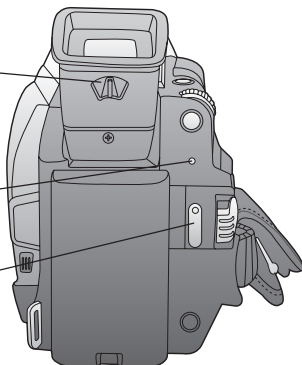

Index of Controls

Underside View

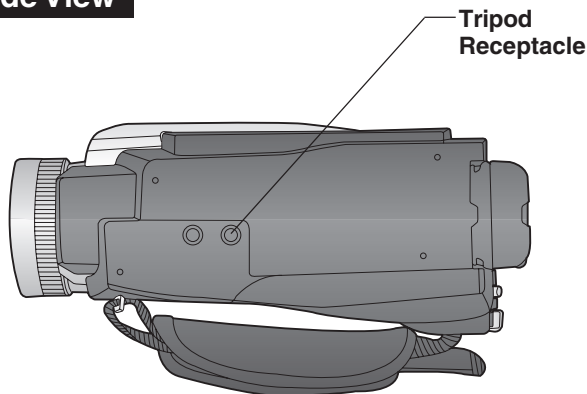

AC Adaptor

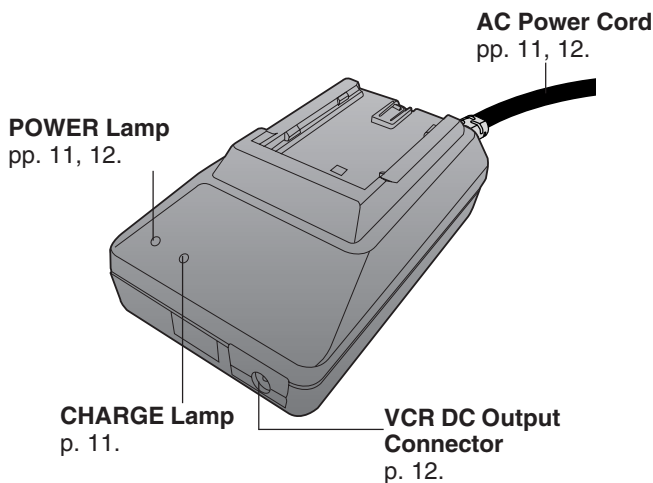

CAUTION:

This unit will operate on 110/120/220/240 V AC. An AC plug adaptor may be required for voltages other than 120V AC. Please contact either a local or foreign electrical parts distributor for assistance in selecting an alternate AC plug. We recommend using the accessory power plug adaptor (VJSS0070/KZDB4ZE00001) in an area which has special AC outlets.

Index

- A**
AC Adaptor ... 6, 11, 12, 46
Accessories (Optional) . 46
Accessories (Supplied) ... 6
Adjusting the Volume 28
A/V Cable 6, 32
Approximate Brightness
 Values 49
Audio Dubbing 38, 39
Audio/Video Fade In/Out
 22
- B**
Backlight 20
Battery Pack ... 6, 9, 11, 46
Battery Remaining
 Indication 63
 Battery Warning 53
Before Requesting Service
 51, 52
Blank Search 28
Built-in Light 8
- C**
CINEMA Mode 20
Cleaning Care for
 Video Heads 51
Clock Battery 53
Clock Set 13
Connecting Earphone ... 27
Copying from Digital
 Equipment 41
 Copying your Tapes 40
Customer Services
 Directory 55
- D**
Date and Time Indication
 64
DC Power Cable . 6, 12, 46
DEW Indication 53
Digital E.I.S. 35
Digital Functions 36
Digital PhotoShot™ Mode
 17
Digital Video Cassette Tape
 6
Digital Zoom 33, 34
DV Interface Cable (i.LINK)
 41, 42, 46
- E**
Easy Cassette Eject 7
Erase Protection Tab 6
EVF/LCD Monitor Indications
 63-64
- F**
Fast Forward/Rewind Check .. 29
Focus 24
- H**
Hand Strap 7
High Speed Shutter 25
How to remove the Sensor
 tag 6
- I**
Important Safeguards 3
Index of Controls 65-67
Iris 26
- J**
Jog Search 30
- L**
LCD/EVF Setting 16
Lens Cap 6, 7, 15
Lens Cap Strap 6, 7
Limited Warranty 54
- M**
MagicPix™ Images 34
Memory Counter 63
MENU OSD 59-62
- O**
On-Screen Displays (OSD)
 53
- P**
Palmcorder Accessory
 Order Form 47
PC Connection 42, 43
PHOTOVU LINK 44, 45
Picture in Picture (PinP)
 37
Playback using the LCD
 Monitor 27
Precautions 4
Program AE 21
Progressive PhotoShot™
 Mode 17
- Q**
Quick Guide 9, 10
- R**
Rapid Visual Search 29
Recording Check 18
Recording Still Pictures ... 19
Repeat Playback 28
Replacing the Bulb 48
Request for Service Notice
 52
- S**
Safety Precautions 2
Self Demo Mode 8
Self Recording 19
Set the Date and Time .. 13
Shoulder Strap 6, 7
Simple Recording 15
Spanish Quick Use Guide
 56-58
Specifications 50
STILL Picture 29
Strobe Multi Mode 31
Supplying Power 11, 12
- T**
Table of Contents 5
Tape Remaining Indications
 63
Tape Speed 6
Tape Warning 53
- U**
Using the Palmcorder Menu
 14
- V**
Variable Speed Search . 30
VHF Connecting Cable
 40
Volume Display 28, 63
- W**
White Balance 23
- Z**
Zoom In/Out 18

Panasonic Consumer Electronics Company,
Division of Matsushita Electric Corporation of America
One Panasonic Way Secaucus, New Jersey 07094

Panasonic Sales Company ("PSC"),
Division of Matsushita Electric of Puerto Rico, Inc.
Ave. 65 de Infantería, Km. 9.5 San Gabriel Industrial Park Carolina,
Puerto Rico 00985



Printed in Japan
LSQT0650B
S1102A2013